

MONITOR WITH RECEIVER  
**INSTRUCTION MANUAL**

ENGLISH

JVCKENWOOD Corporation

---

## DMX7722DABS

**This instruction manual is used to describe the models listed above. Model availability and features (functions) may differ depending on the country and sales area.**

# Important Notice

To ensure proper use, please read through this manual before using this product. It is especially important that you read and observe **WARNINGS** and **CAUTIONS** in this manual.

Please keep the manual in a safe and accessible place for future reference.

## WARNINGS

### To prevent accidents and damages

- DO NOT install any unit or wire any cable in a location where;
  - it may obstruct the steering wheel and gearshift lever operations.
  - it may obstruct the operation of safety devices such as air bags.
  - it may obstruct visibility.
- DO NOT raise the volume level too much, as this will make driving dangerous by blocking outside sounds, and may cause hearing loss.
- DO NOT operate the unit while driving. If you need to operate the unit while driving, be sure to look around carefully.
- Stop the car before performing any complicated operations.
- The driver must not watch the monitor while driving.

## CAUTIONS

### To care for the unit

- If you have parked the car for a long time in hot or cold weather, wait until the temperature in the car becomes normal before operating the unit.

### To care for the monitor

- The monitor built into this unit has been produced with high precision, but it may have some ineffective dots. This is inevitable and is not considered defective.
- Do not expose the monitor to direct sunlight.
- Do not operate the touch panel using a ball-point pen or similar tool with a sharp tip. Touch the keys on the touch panel with your finger directly (if you are wearing a glove, take it off).
- When the temperature is very cold or very hot...
  - Chemical changes occur inside, causing malfunction.
  - Pictures may not appear clearly or may move slowly. Pictures may not be synchronised with the sound or picture quality may decline in such environments.

### On the volume setting

- Digital devices produce very little noise compared with other sources. Lower the volume before playing these digital sources to avoid damaging the speakers by sudden increase of the output level.

## About GPS

When you turn on this unit for the first time, you must wait while the system acquires GPS signals from satellites. This process could take up to several minutes. Make sure your vehicle is outdoors in an open area away from tall buildings and trees for fastest acquisition. Once the system acquires GPS signals, this unit will acquire them quickly each time you turn on this unit.



### Information on Disposal of Old Electrical and Electronic Equipment and Batteries (applicable for countries that have adopted separate waste collection systems)

Products and batteries with the symbol (crossed-out wheeled bin) cannot be disposed as household waste. Old electrical and electronic equipment and batteries should be recycled at a facility capable of handling these items and their waste by products. Contact your local authority for details in locating a recycle facility nearest to you. Proper recycling and waste disposal will help conserve resources whilst preventing detrimental effects on our health and the environment.

## Important Notice



**Declaration of Conformity with regard to the RE Directive 2014/53/EU**

**Declaration of Conformity with regard to the RoHS Directive 2011/65/EU**

**Manufacturer:**

JVCKENWOOD Corporation  
3-12, Moriya-cho, Kanagawa-ku, Yokohama-shi,  
Kanagawa, 221-0022, JAPAN

**EU Representative:**

JVCKENWOOD Europe B.V.  
Rendementsweg 20 B-9, 3641 SL Mijdrecht,  
THE NETHERLANDS

**English**

Hereby, JVCKENWOOD declares that the radio equipment "DMX7722DABS" is in compliance with Directive 2014/53/EU.

The full text of the EU declaration of conformity is available at the following internet address:  
<https://www.kenwood.com/euukdoc/>

**Français**

Par la présente, JVCKENWOOD déclare que l'équipement radio « DMX7722DABS » est conforme à la directive 2014/53/UE.

L'intégralité de la déclaration de conformité UE est disponible à l'adresse Internet suivante :  
<https://www.kenwood.com/euukdoc/>

**Deutsch**

Hiermit erklärt JVCKENWOOD, dass das Funkgerät "DMX7722DABS" der Richtlinie 2014/53/EU entspricht. Der volle Text der EU-Konformitätserklärung steht unter der folgenden Internetadresse zur Verfügung:  
<https://www.kenwood.com/euukdoc/>

**Nederlands**

Hierbij verklaart JVCKENWOOD dat de radioapparatuur "DMX7722DABS" in overeenstemming is met Richtlijn 2014/53/UE.  
De volledige tekst van de EU-verklaring van overeenstemming is te vinden op het volgende internetadres:  
<https://www.kenwood.com/euukdoc/>

**Italiano**

Con la presente, JVCKENWOOD dichiara che l'apparecchio radio "DMX7722DABS" è conforme alla Direttiva 2014/53/UE.  
Il testo integrale della dichiarazione di conformità UE è disponibile al seguente indirizzo internet:  
<https://www.kenwood.com/euukdoc/>

**Español**

Por la presente, JVCKENWOOD declara que el equipo de radio "DMX7722DABS" cumple la Directiva 2014/53/UE.  
El texto completo de la declaración de conformidad con la UE está disponible en la siguiente dirección de internet:  
<https://www.kenwood.com/euukdoc/>

**Português**

Deste modo, a JVCKENWOOD declara que o equipamento de rádio "DMX7722DABS" está em conformidade com a Diretiva 2014/53/UE.  
O texto integral da declaração de conformidade da UE está disponível no seguinte endereço de internet:  
<https://www.kenwood.com/euukdoc/>

**Polska**

Niniejszym, JVCKENWOOD deklaruje, że sprzęt radiowy "DMX7722DABS" jest zgodny z dyrektywą 2014/53/UE.  
Pełny tekst deklaracji zgodności EU jest dostępny pod adresem:  
<https://www.kenwood.com/euukdoc/>

**Český**

Společnost JVCKENWOOD tímto prohlašuje, že rádiové zařízení "DMX7722DABS" splňuje podmínky směrnice 2014/53/UE.  
Plný text EU prohlášení o shodě je dostupný na následující internetové adrese:  
<https://www.kenwood.com/euukdoc/>

**Magyar**

JVCKENWOOD ezennel kijelenti, hogy a „DMX7722DABS” rádióberendezés megfelel a 2014/53/UE irányelvnek.  
Az EU konformitási nyilatkozat teljes szövege az alábbi weboldalon érhető el:  
<https://www.kenwood.com/euukdoc/>

## Important Notice

### Svenska

Härmed försäkrar JVCKENWOOD att radioustrustningen "DMX7722DABS" är i enlighet med direktiv 2014/53/EU. Den fullständiga texten av EU-försäkran om överensstämmelse finns på följande Internetadress: <https://www.kenwood.com/euukdoc/>

### Suomi

JVCKENWOOD julistaa täten, että radiolaite "DMX7722DABS" on direktiivin 2014/53/EU mukainen. EU-vaatimustenmukaisuusvaatimus löytyy kokonaisuudessaan seuraavasta internet-osoitteesta: <https://www.kenwood.com/euukdoc/>

### Slovensko

S tem JVCKENWOOD izjavlja, da je radijska oprema » DMX7722DABS « v skladu z Direktivo 2014/53/EU. Celotno besedilo direktive EU o skladnosti je dostopno na tem spletnem naslovu: <https://www.kenwood.com/euukdoc/>

### Slovensky

Spoločnosť JVCKENWOOD týmto vyhlasuje, že rádiové zariadenie „DMX7722DABS“ vyhovuje smernici 2014/53/EÚ. Celý text EÚ vyhlásenia o zhode nájdete na nasledovnej internetovej adrese: <https://www.kenwood.com/euukdoc/>

### Dansk

Herved erklærer JVCKENWOOD, at radioudstyret "DMX7722DABS" er i overensstemmelse med Direktiv 2014/53/EU. EU-overensstemmelseserklæringens fulde ordlyd er tilgængelig på følgende internetadresse: <https://www.kenwood.com/euukdoc/>

### Ελληνικά

Με το παρόν, η JVCKENWOOD δηλώνει ότι ο ραδιοεξοπλισμός «DMX7722DABS» συμμορφώνεται με την Οδηγία 2014/53/ΕΕ. Το πλήρες κείμενο της δήλωσης συμμόρφωσης της ΕΕ είναι διαθέσιμο στην ακόλουθη διεύθυνση στο διαδίκτυο: <https://www.kenwood.com/euukdoc/>

### Eesti

Käesolevaga JVCKENWOOD kinnitab, et „DMX7722DABS” raadiovarustus on vastavuses direktiiviga 2014/53/EL. ELi vastavusdeklaratsiooni terviktekst on kättesaadav järgmisel internetiaadressil: <https://www.kenwood.com/euukdoc/>

### Latviešu

JVCKENWOOD ar šo deklarē, ka radio aparātūra „DMX7722DABS” atbilst direktīvas 2014/53/ES prasībām. Pilns ES atbilstības deklarācijas teksts ir pieejams šādā tīmekļa adresē: <https://www.kenwood.com/euukdoc/>

### Lietuviškai

Šiuo JVCKENWOOD pažymi, kad radijo įranga „DMX7722DABS” atitinka 2014/53/EB direktyvos reikalavimus. Visą EB direktyvos atitikties deklaracijos tekstą galite rasti šiuo internetiniu adresu: <https://www.kenwood.com/euukdoc/>

### Malti

B'dan, JVCKENWOOD jiddikjara li t-tagħmir tar-radju "DMX7722DABS" huwa konformi mad-Direttiva 2014/53/UE. It-test kollu tad-dikjarazzjoni ta' konformità huwa disponibbli fl-indirizz intranet li ġej: <https://www.kenwood.com/euukdoc/>

### HRVATSKI / SRPSKI JEZIK

JVCKENWOOD ovim izjavljuje da je radio oprema "DMX7722DABS" u skladu s Direktivom 2014/53/EU. Cjeloviti tekst deklaracije Europske unije o usklađenosti dostupan je na sljedećoj internet adresi: <https://www.kenwood.com/euukdoc/>

### ROMÂNĂ

Prin prezenta, JVCKENWOOD declară că echipamentul radio "DMX7722DABS" este în conformitate cu Directiva 2014/53/UE. Textul integral al declarației de conformitate UE este disponibil la următoarea adresă de internet: <https://www.kenwood.com/euukdoc/>

## Important Notice

### БЪЛГАРСКИ

С настоящото JVCKENWOOD декларира, че радиооборудването на "DMX7722DABS" е в съответствие с Директива 2014/53/ЕС.

Пълният текст на ЕС декларацията за съответствие е достъпен на следния интернет адрес:  
<https://www.kenwood.com/euukdoc/>

### Turkish

Burada, JVCKENWOOD "DMX7722DABS" radyo ekipmanının 2014/53/AB Direktifine uygun olduğunu bildirir.

AB uyumluluk deklarasyonunun tam metni aşağıdaki internet adresinde mevcuttur.  
<https://www.kenwood.com/euukdoc/>

### Русский

JVCKENWOOD настоящим заявляет, что радиооборудование «DMX7722DABS» соответствует Директиве 2014/53/EU.

Полный текст декларации соответствия ЕС доступен по следующему адресу в сети Интернет:  
<https://www.kenwood.com/euukdoc/>

### Українська

Таким чином, компанія JVCKENWOOD заявляє, що радіобладнання «DMX7722DABS» відповідає Директиві 2014/53/EU.

Повний текст декларації про відповідність ЄС можна знайти в Інтернеті за такою адресою:  
<https://www.kenwood.com/euukdoc/>



**Declaration of Conformity with regard to the Radio Equipment Regulations 2017 (S.I. 2017/1206)**  
**Declaration of Conformity with regard to the Restriction of the Use of Certain Hazardous Substances in Electrical and Electronic Equipment Regulations 2012 (S.I. 2012/3032)**

### Manufacturer:

JVCKENWOOD Corporation  
3-12, Moriya-cho, Kanagawa-ku, Yokohama-shi,  
Kanagawa, 221-0022, JAPAN

### UK Importer:

JVCKENWOOD U.K. Limited  
First Floor, Gleneagles, the Belfry, Colonial Way,  
Watford, Hertfordshire WD24 4WH, UNITED KINGDOM

Hereby, JVCKENWOOD declares that the radio equipment "DMX7722DABS" is in compliance with the relevant statutory requirements.

The full text of the declaration of conformity is available at the following internet address:  
<https://www.kenwood.com/euukdoc/>

### For Israel

מידע בדבר השלכה לאספה של ציוד חשמלי ואלקטרוני ישו וכן סוללות (רלוונטי למדינות שמשתמשות במערכת איסוף אשפה מופרדת).

לא ניתן להשליך מוצרים וסוללות עם הסיומן (פח אשפה עם X עליו) כאשפה ביתית רגילה. יש למחור ציוד חשמלי ואלקטרוני ישו וכן סוללות במתקן המסוגל לטפל בפריטים כאלה ובתוצרי הלואזי שלהם. צרו קשר עם הרשות המקומית לקבלת פרטים אודות מתקן המיחזור הקרוב אליכם. מיחזור והשלכה לאספה נאותים יעזרו לשמר משאבים ולמנוע השפעות שליליות על בריאותנו ועל הסביבה.

## About this manual

The displays and panels shown in this manual are examples used to provide clear explanations of the operations. For this reason, they may be different from the actual displays or panels.

This manual mainly explains operations using the buttons on the monitor panel and keys on the touch panel. For operations using the remote controller, see page 47.

< > indicates the various screens/menus/operations/settings that appear on the touch panel.

[ ] indicates the keys and source names on the touch panel.

Indication language: English indications are used for the purpose of explanation. You can select the indication language from the <SET-UP> menu (page 43).



This symbol on the product means there are important operating and maintenance instructions in this manual. Be sure to carefully read instructions in this manual.

# Contents

<b>Component Names and Basic Operations.....</b>	<b>3</b>	<b>USB .....</b>	<b>18</b>	<b>Settings .....</b>	<b>35</b>
Monitor panel.....	3	Playback operations.....	18	Audio settings .....	35
Home screen.....	3	Video playback operations.....	19	Display settings.....	39
Turning on the power.....	3	Search operations.....	20	Input settings.....	41
Turning off the power.....	3	Settings for USB playback.....	21	System settings.....	42
Putting the unit in standby.....	4	<b>Digital Radio (DAB) .....</b>	<b>22</b>	<b>Remote Controller.....</b>	<b>46</b>
Turning off the screen.....	4	Listening to the radio.....	22	Preparation .....	46
Adjusting the volume.....	4	Presetting services in the memory.....	24	Basic operations for KCA-RCDV340.....	47
Attenuating the sound.....	4	Selecting a preset service.....	24	<b>Installation and Connection .....</b>	<b>48</b>
Initial settings.....	4	Settings for Digital Radio.....	24	Before installation .....	48
Date and clock settings.....	5	<b>Radio .....</b>	<b>25</b>	Installing the unit.....	49
<b>In-Car Connections.....</b>	<b>6</b>	Listening to the radio.....	25	Removing the unit .....	50
USB connection.....	6	Presetting stations in the memory.....	26	Installing the supplied GPS aerial.....	50
Bluetooth® connection.....	7	Selecting a preset station.....	27	Connecting external components.....	51
Connections setting.....	11	Settings for other Radio Data System features.....	27	Wiring connection.....	52
<b>Various Screens and Operations .....</b>	<b>12</b>	<b>Other External Components .....</b>	<b>28</b>	<b>References .....</b>	<b>53</b>
Source/option selection screen.....	12	AV-IN devices.....	28	Maintenance .....	53
Source control screen.....	13	Cameras.....	29	More information.....	53
List/setting screen.....	14	<b>Bluetooth® Device .....</b>	<b>30</b>	<b>Troubleshooting.....</b>	<b>55</b>
<b>Apps .....</b>	<b>15</b>	Bluetooth mobile phone.....	30	<b>Specifications .....</b>	<b>58</b>
Using Apps of iPhone — Apple CarPlay.....	15	Bluetooth mobile phone settings.....	32	<b>Trademarks and Licences .....</b>	<b>61</b>
Using the Apps of an Android™ device		Bluetooth audio player.....	33	Important Notice on Software.....	62
— Android Auto™.....	16			EULA.....	62
Using the Apps of an Android device					
— USB Mirroring.....	17				

# Component Names and Basic Operations

## Monitor panel

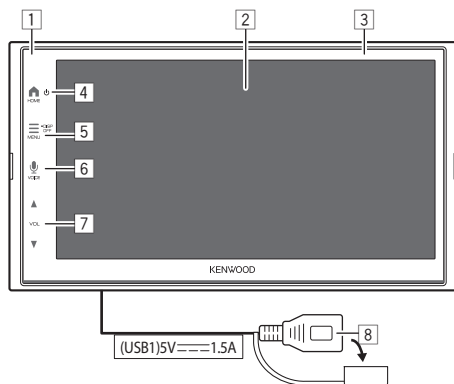

- 1 Remote sensor
- 2 Screen (touch panel)
- 3 Monitor panel
- 4 **HOME** button
  - (Press): Turns on the power.
  - (Hold): Turns off the power.
  - **HOME** (Press): Displays the Home screen (see the following) while the power is on.
- 5 **MENU/DISP OFF** button
  - **MENU** (Press): Pops up the function menu (page 14).
  - **DISP OFF** (Hold): Turns off the screen.

- 6 **VOICE** button: (Press) Activates the voice recognition.
  - When no device for Apple CarPlay, Android Auto, and Bluetooth phone is connected, pressing and holding this button displays Bluetooth pairing waiting dialog (page 7).
- 7 **VOL** ▲/▼ buttons
- 8 USB terminal from the rear panel

The buttons on the monitor illuminate and change the colour periodically with the unit turned on.

- To change the colour, see page 40.

## Home screen

- You can customize the Home screen (page 41).
- To display the Home screen from other screens, press the **HOME** button.



Touching the operation keys performs the following actions:

- 1 Displays the control screen of current source.
- 2 Displays the source/option selection screen.
- 3 Short-cut playback source icons
- 4 Displays the Hands Free screen when a Bluetooth phone is connected.
  - When connected as Apple CarPlay or Android Auto, it works as a phone provided in Apple CarPlay or Android Auto.

## Turning on the power



- When you turn on this unit for the first time, you must wait while the system acquires GPS signals from satellites. This process could take up to several minutes.

## Turning off the power



# Component Names and Basic Operations

## Putting the unit in standby

### 1 Display the source/option selection screen.

From the Home screen (page 3), touch as follows:



### 2 Put the unit in standby.

On the source/option selection screen (page 12):



## Turning off the screen

### ■ On the monitor panel

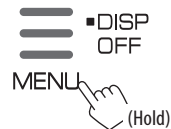

**To turn on the screen:** Press the **DISP OFF** button on the monitor panel or touch the screen.

### ■ On the pop-up menu



**To turn on the screen:** Touch the screen.

## Adjusting the volume

▲ You can adjust the volume (00 to 40) by pressing VOL ▲ to increase and pressing VOL ▼ to decrease.



- When volume level is below 15, holding VOL ▲ increases the volume continuously to level 15.

## Attenuating the sound

On the source control screen:



**To cancel attenuation:**



## Initial settings

When you power on the unit for the first time or initialised, the **<Initial Setup>** screen appears.

**Perform the initial settings.**

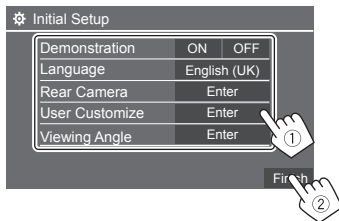

Once completed, Home screen appears.

**<Demonstration>** (page 41)

- **ON** (Initial): Activates the display demonstration.
- **OFF**: Deactivates the display demonstration.

**<Language>** (page 43)

Select the text language used for on-screen information.

- **English** (American English)/**English (UK)**(Initial)/**Español/Français/Deutsch/Italiano/Nederlands/Russкий/Português/עברית/Ελληνικά/Πolski/Čeština/Magyar**
- **GUI Language: Local** (the language selected above) (Initial)/**English**: Selects the language used for displaying operation keys and menu items.

**<Rear Camera>** (page 42)

Make the settings to display the picture from the connected rear view camera.

**<User Customize>** (page 40)

Change the display design.

**<Viewing Angle>** (page 41)

Select the viewing angle in relation to the monitor to make the image on the screen easier to see.

- **Under 0°** (Initial)/**5°/10°/15°/20°**



# Component Names and Basic Operations

## Date and clock settings

### 1 Display the Home screen.



### 2 Display the <SET-UP> screen.

From the Home screen (page 3), touch as follows:



### 3 Display the <System> screen (①), and then enter the item-setting screen you want to change (②).

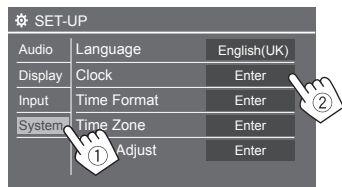

Eg. When selecting <Clock>

### 4 Set or adjust the date and clock items.

#### <Clock>\*

Select the method to set the date and clock.

- **GPS-SYNC** (Initial): Synchronises the clock time with GPS.
- **Manual**: Sets the clock manually using <Clock Adjust>. See the following.

#### <Time Format>

Select the time display format.

- **[12-Hour]/[24-Hour]** (Initial)

#### <Time Zone>

Select the time zone for your residential area.

- **London, Dublin** (Initial)/**Amsterdam, Berlin**, etc.

#### <Clock Adjust>

Touch [▲]/[▼] (①) to adjust the date (year/month/date), and adjust the hour/minute. Touch [SET] (②) to finish setting the clock.

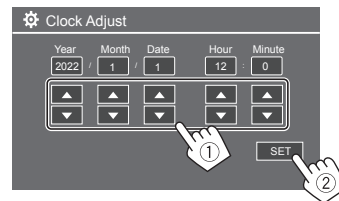

#### <Daylight Saving Time>

(Not used when the clock is set manually)

Activate this by selecting the additional time for Daylight Saving Time (if available in your residential area).

- **OFF** (Initial)/**30min/1Hr**

\* You can also display the <Clock> screen by touching the clock area if shown on the Home screen.

# In-Car Connections

To operate your smartphone hands-free, and Apps of the smartphone (Apple CarPlay, Android Auto, and USB Mirroring), the following connections are required.

- **For Wired Apple CarPlay** (page 15), connect iPhone with USB.
- **For Wireless Apple CarPlay** (page 15), connect iPhone with Bluetooth (Wi-Fi is auto-connected).
- **For Android Auto** (page 16)
  - Android device with Android version 6.0 or later can be used with USB (In this case, Bluetooth is auto-connected, but Wi-Fi is not available)
  - To wirelessly use Android Auto with this unit, connect Android device with Bluetooth (Wi-Fi is auto-connected)
  - You need a compatible Android device (see below) with an active data plan.
    - An Android device with Android version 11 or later and 5 GHz Wi-Fi (subject to local regulations\*); or
    - A Google-branded or Samsung-branded device with Android version 10; or
    - A Samsung Galaxy S8, Galaxy S8+ or Note 8, with Android 9
  - You can find more information at [g.co/androidauto/requirements](http://g.co/androidauto/requirements).

\* Refer to the local regulations of your residential area.

- **For USB Mirroring** (page 17), connect the Android device both with USB and Bluetooth.
- **For Hands-Free Phone** (page 30) **and Bluetooth audio player** (page 33), connect your device with Bluetooth®.

• For AV-IN device connection and its usage, see pages 28 and 51.

## USB connection

Connect your smartphone (iPhone or Android device) for using Apps on the screen of this unit.

- You can also connect a USB mass storage class device such as a USB memory, digital audio player, etc. to the unit. But you cannot connect a PC, portable HDD and USB hub.

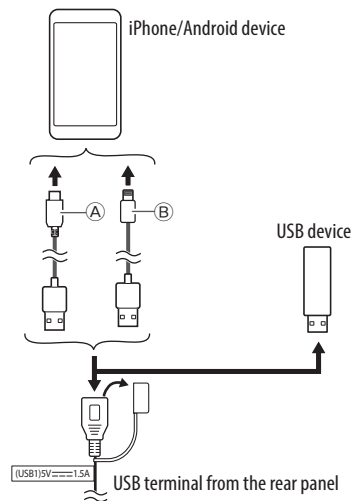

- Ⓐ For connecting your Android device, use the USB cable (commercially available)
- Ⓑ For connecting your iPhone, use the USB cable for iPhone KCA-iP103 (optional accessory)

### Bluetooth® connection

#### Information for using Bluetooth devices

Bluetooth is a short-range wireless radio communication technology for mobile devices such as mobile phones (smartphones), portable PCs, and other devices. Bluetooth devices can be connected without cables and communicate with each other.

- Some Bluetooth devices may not be used with this unit depending on the Bluetooth version of the device.

#### Pairing a Bluetooth device

When you connect a Bluetooth device to the unit for the first time, register the device to this unit (pairing). Pairing allows Bluetooth devices to communicate with each other.

- The pairing method differs depending on the Bluetooth version of the device.
  - For devices with Bluetooth 2.1:  
You can pair the device and the unit using SSP (Secure Simple Pairing) which only requires confirmation.
  - For devices with Bluetooth 2.0:  
You need to enter a PIN code both on the device and the unit for pairing.

- Once the connection is established, it is registered in the unit until you initialise the Bluetooth settings (page 43) or the unit itself (page 44). Up to five devices can be registered in total.
- To use the Bluetooth function, you need to turn on the Bluetooth function of the device.

#### Auto pairing

When **<Auto Pairing>** is set to **[ON]** (page 33), Bluetooth devices are automatically paired.

- For iPhone with Apple CarPlay and Android device with Android Auto: When the device is connected via USB, it is automatically paired regardless of this setting.

#### Automatic Wi-Fi connections

This unit is equipped with the Wi-Fi function. Once your iPhone or Android device is paired successfully with Bluetooth or connected with USB for Apple CarPlay or for Android Auto, it is automatically connected with Wi-Fi. And from the next time on, it is automatically connected through Wi-Fi.

- Turn on the Bluetooth and Wi-Fi functions on your iPhone or Android device.
- It is necessary to connect the GPS aerial in order to use wireless Apple CarPlay.

#### Pairing a Bluetooth device using SSP (for Bluetooth 2.1)

##### 1 Display the Home screen.



##### 2 Display the <Device List> screen.

From the Home screen (page 3), touch as follows:

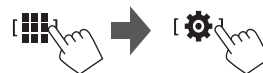

Then, on the **<SET-UP>** screen, touch as follows:  
**[System]** → **<Connections SETUP>** : **[Enter]**

On the **<Connections SETUP>** screen, touch as follows:

**<Device List>** : **[Enter]**

- You can also use the pop-up function menu to display the **<Device List>** screen (page 14).

##### 3 Make the unit ready for pairing.

On the **<Device List>** screen:



### 4 Search for the unit “DMX7722DABS” from your Bluetooth device.

### 5 Confirm the request both on the device and the unit.

On the device:

Confirmation method varies for the device.

On the unit:



Pairing is complete.

**To reject the request:** Touch **[Cancel]**.

### 6 Register the usage of the Bluetooth device.

- See “Registering the usage of the devices” on page 9.

Once pairing is completed...

#### • For iPhone compatible with wireless Apple CarPlay

A confirmation message appears.

- Touch **[Yes]** to display the Apple CarPlay screen for wireless connection.

- Touch **[No]** not to use Apple CarPlay for the time being. To use Apple CarPlay, select it on the **<Device List>** screen.

#### • For Android device compatible with Android Auto

When **[Android Auto]** (Initial) is selected for the **<Android Mode Select>** setting (page 12), Android Auto is automatically activated, and this Android device is registered as Android Auto device.

- If Apple CarPlay is active currently, a warning message may appear, asking whether Android Auto or Apple CarPlay is to be used (depending on iPhone version).

## Pairing a Bluetooth device using a PIN code (for Bluetooth 2.0)

### 1 Display the Home screen.



### 2 Display the <PIN Code Set> screen.

From the Home screen (page 3), touch as follows:



Then, on the **<SET-UP>** screen, touch as follows:  
**[System]** → **<Connections SETUP>** : **[Enter]**

On the **<Connections SETUP>** screen, touch as follows:  
**<PIN Code>** : **[Enter]**

### 3 Enter the PIN code.

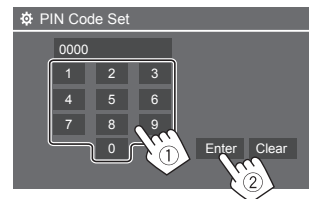

- Initial PIN Code: [0000]
- If you do not need to change the PIN code [0000], just touch **[Enter]**.
- To change the PIN code, see page 11.

## In-Car Connections

### 4 Make the unit ready for pairing.

On the <Device List> screen:



Please open Bluetooth settings on your device and select the device name below

DMXXXXXX

Cancel

### 5 Search for the unit "DMX7722DABS" from your Bluetooth device.

### 6 Select the unit "DMX7722DABS" on your Bluetooth device.

Pairing is complete.

### 7 Register the usage of the Bluetooth device.

- See "Registering the usage of the devices" that follows.

Once pairing is completed, see page 8.

- **For iPhone compatible with wireless Apple CarPlay**
- **For Android device compatible with Android Auto**

## ■ Registering the usage of the devices

You can confirm and change the usage (profile) of the registered devices on the <Device List> screen.

- You can also connect/disconnect and delete unwanted devices on the device list.

### 1 Display the <Device List> screen.

From the Home screen (page 3), touch as follows:



Then, on the <SET-UP> screen, touch as follows:  
[System] → <Connections SETUP> : [Enter]

On the <Connections SETUP> screen, touch as follows:

<Device List> : [Enter]

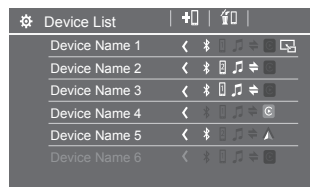

The currently activated (connected) devices are highlighted on the list.

- Six devices can be displayed on the list; five devices connected by Bluetooth and one by USB.
- You can also use the pop-up function menu to display the <Device List> screen (page 14).
- Touch [<] scrolls the text if not all of the text is shown.
- For list/setting screen operations, see also page 14.

### 2 Select the device you want to use.

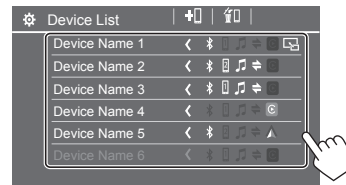

- When Apple CarPlay or Android Auto is activated for the selected device, it will be disconnected. A warning message appears. Touch [Yes] to continue.

## 3 Select the profile for the selected device.

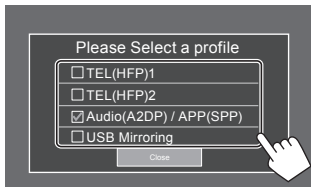

- **[TEL(HFP)1]/[TEL(HFP)2]:** To use the device as hands-free phone 1 and 2.
- **[Audio(A2DP)/APP(SPP):** To use the device as Bluetooth audio or Apps (Apple CarPlay/Android Auto).
- **[USB Mirroring]:** To use the device as USB Mirroring.

## 4 Touch <Close> to finish.

The <Device List> screen is displayed again. This unit searches for the device you have just set the usage (profile) for, and activates the device if it is connected.

### About the profile icons

- Available profile for the listed devices are in white. When the profile is active for the devices, it becomes blue. Unavailable device and profile are in gray.
- Bluetooth icon is displayed only when the device is connected by Bluetooth.
- Apple CarPlay and Android Auto icons illuminate when they are active.
- Mirroring icon is displayed when the device is selected as Mirroring in profile setting.

Icon	Profile	Status (on/off/unavailable)
	Bluetooth	Bluetooth connection
	HFP1	Hands-Free phone 1
	HFP2	Hands-Free phone 2
	A2DP	Bluetooth audio player
	SPP	Apps
	Apple CarPlay	Apple CarPlay
	Android Auto	Android Auto
	Mirroring	USB Mirroring

## ■ Adding the registered devices

### 1 Display the <Device List> screen.

From the Home screen (page 3), touch as follows:



Then, on the <SET-UP> screen, touch as follows:  
[System] → <Connections SETUP> : [Enter]

On the <Connections SETUP> screen, touch as follows:

<Device List> : [Enter]

### 2 Activate registration.

On the <Device List> screen:



### 3 Follow the procedure previously explained.

- Pairing a Bluetooth device using SSP (for Bluetooth 2.1), see page 7.
- Pairing a Bluetooth device using a PIN code (for Bluetooth 2.0), see page 8.

## In-Car Connections

### ■ Deleting the registered devices

#### 1 Display the <Device List> screen.

From the Home screen (page 3), touch as follows:



Then, on the <SET-UP> screen, touch as follows:  
**[System]** → <Connections SETUP> : **[Enter]**

On the <Connections SETUP> screen, touch as follows:

<Device List> : **[Enter]**

#### 2 Display the <Device Remove> screen.

On the <Device List> screen:



#### 3 Select the device you want to delete.

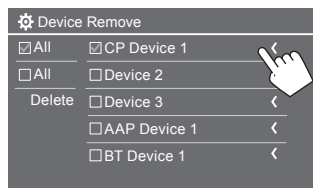

- To select all devices, touch  All.
- To deselect all devices, touch  All.

#### 4 Touch [Delete].

A warning message appears. Touch **[Yes]** to delete.

### Connections setting

You can change various settings for the connected devices.

#### 1 Display the <Connections SETUP> screen.

From the Home screen (page 3), touch as follows:



Then, on the <SET-UP> screen, touch as follows:  
**[System]** → <Connections SETUP> : **[Enter]**

On the <Connections SETUP> screen, you can change and confirm the following item settings.

- For list/setting screen operations, see also page 14.

Connections SETUP	
Device List	Enter
PIN Code	0000
Device Name	(Model name)
Bluetooth Device Address	00:00:00:00:00:00
Initialise	Enter ↓
TEL SET-UP	Enter

Connections SETUP	
Wi-Fi Setup	Enter
Device Audio Control	Enter
Driving Position	Left Right
Android Mode Select	Enter
Reset Android Auto Wireless Connection	Enter

#### <Device List>

Devices connected for Apple CarPlay, Android Auto, USB Mirroring, Bluetooth phone, and Bluetooth audio are listed. You can check their names and their status on the list (page 9).

#### <PIN Code>

- To change the PIN code, enter a new PIN code and touch **[Enter]** to finish.
- To correct the PIN code input, touch and hold **[Clear]**, and re-enter the PIN code.
- This setting is available only when iPhone with Apple CarPlay is not connected.

#### <Device Name>

Shows the device name of this unit to be shown on the Bluetooth device — **DMX7722DABS**.

#### <Bluetooth Device Address>

Shows the Bluetooth device address of this unit.

#### <Initialise>

Initialise the Bluetooth settings (page 43).

#### <TEL SET-UP>

See step 2 on page 33.

- This setting is available only when iPhone with Apple CarPlay is not connected.

### <Wi-Fi Setup>

Shows the device name, device address and password of this unit.

### <Device Audio Control>

Go to step 2.

### <Driving Position>

Set your driver's seat position of your car — **[LEFT]** (Initial) or **[RIGHT]**.

This setting changes the sidebar/button position of Apple CarPlay/Android Auto screens accordingly with the driver seat position.

- This setting is available only when iPhone with Apple CarPlay and Android device with Android Auto are not connected.

### <Android Mode Select>

Select Android device usage for Apps — either **[Android Auto]** (page 16) or **[Mirroring for Android]** (page 17).

- This setting is available only in Standby Mode with no device connected via USB.

### <Reset Android Auto Wireless Connection>

Reset Android Auto wireless connection when you want to change the password for wireless connection manually. The system of this unit is rebooted after touching **[Yes]**.

## 2 Touch **[Enter]** to display the selected item screen.

On the **<Device Audio Control>** screen:

Device Audio Control	
Guidance/Voice Recognition Volume	Enter
Phone Incoming Volume	Enter
Phone Calling/Talking Volume	Enter
Speech Quality Adjust	Enter
Media Volume	◀ 15 ▶

- **<Guidance/Voice Recognition Volume>** can be set separately for **<Apple CarPlay>** and **<Android Auto>** within the range of 00 to 40 (Initial: 19).
- **<Phone Incoming Volume>**, **<Phone Calling/Talking Volume>** can be set separately for **<Apple CarPlay>** and **<Android Auto/Bluetooth>** within the range of 00 to 40 (Initial: 15).
- **<Speech Quality Adjust>**:  
**<Microphone Level>** can be set within the range of -10 to +10 (Initial: -4).  
**<Echo Cancel Level>**, **<Noise Reduction Level>** can be set within the range of -5 to +5 (Initial: 0).
- **<Media Volume>** can be set within the range of 00 to 40 (Initial: 15).

## Various Screens and Operations

You can display or change to other screens at any time to show information, change the playback source, change the settings, etc.

### Source/option selection screen

Touch **[Home]** on the Home screen to display the source/option selection screen.

- Only the available icons at that time are shown on the screen.

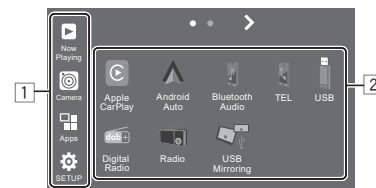

Touching the operation keys performs the following actions:

#### 1 Left-side keys

**[Now Playing]** Displays the control screen of current source.

**[Camera]** Switches to the camera view (page 29).

**[Apps]** Switches to the currently available Apps—**[Apple CarPlay]** or **[Android Auto]**.

**[SETUP]** Displays the **<SET-UP>** screen (page 35).



## Various Screens and Operations

### [2] Source/option keys

**[Apple CarPlay]** Displays the home screen of Apple CarPlay.

**[Android Auto]** Displays the home screen of Android Auto.

**[Bluetooth Audio]** Plays a connected Bluetooth audio player.

**[TEL]** Displays the phone control screen.

**[USB]** Plays files on a USB device.

**[Digital Radio]** Switches to the Digital Radio (DAB).

**[Radio]** Switches to the radio broadcast.

**[USB Mirroring]** Displays the screen of USB Mirroring.

**[AV-IN]** Switches to the external AV component connected to the AV-IN input terminal.

**[STANDBY]** Puts the unit in standby.

**To change the page:** Touch [ > ] / [ < ]. Current page is shown by the page indication on the top of the screen.

**To return to the Home screen:** Press the **HOME** button on the monitor panel.

### Source control screen

You can operate the playback source using the source control screen.

- The operation keys and information displayed vary for each source. Here the common operation keys are explained. For more about the other operation keys, see the respective page of each source section.

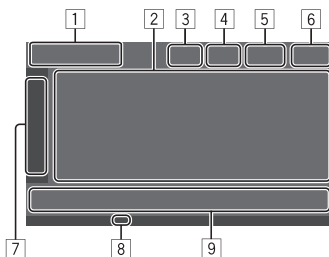

- [1]** Current playback source icon and name
  - Touch [ > ] to show the source icons on the Home screen. Then touch [ < ] to hide the other icons.
- [2]** Content information area
  - Touch [ < ] to scroll the text if not all of the text is shown.
  - Touch [ < ] to widen the window to show more detailed information. Then touch [ > ] to close the window.

- [3]** Phone control screen indicator
  - Touch to display the phone control screen (page 31).
- [4]** Sound attenuating key (page 4)
- [5]** TEL indicator is shown when a hands-free phone is connected.
- [6]** Clock display
- [7]** Operation window tab
  - Touch [ > ] to widen the operation window to show more operation keys besides those shown on the operation key area [9]. Then touch [ < ] to close the window.
- [8]** TI indicator (pages 23 and 26)
- [9]** Operation key area

## Various Screens and Operations

### Using the pop-up function menu





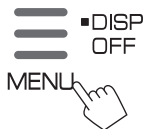

You can easily access the frequently used features.

#### 1 Display the pop-up function menu.



#### 2 Touch one of the following items you want to use.



[  Device List ]	Displays the <Device List> screen (page 9).
[  Screen Adjustment ]	Displays the <Screen Adjustment> screen (page 41).
[  Display OFF ]	Turns off the screen. • To turn on the display, touch anywhere on the screen.
[  Camera ]	Displays the view from the connected camera (page 29).
[  SETUP ]	Displays the <SET-UP> screen (page 35).
[  Standby ]	Icon varies depending on current playing source.

**To close the pop-up function menu:** Touch the screen anywhere other than the pop-up function menu.

### List/setting screen

Below are the common operation keys which appear on the list/setting screen.

- The appearance or location of the operation keys may differ, however the similar operation keys have the same operations.
- Available operation keys differ depending on the setting screens. Not all these operation keys are shown on every screen.

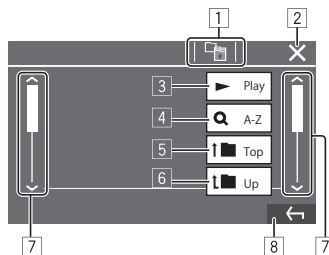

Touching the operation keys performs the following actions:

- 1 Return to the upper layer.\*1
- 2 Finishes the setting and closes the current screen.
- 3 Plays all files in the folder containing the current file.

- 4 (Not displayed for folder list) Enters alphabet search to list the items in alphabetical order.\*2  
When a key pad is displayed, follow the procedure below.

- 1 Touch the first letter you want to search for.
  - To search by a number, touch [1,2,3...].
  - To search by a symbol, touch [#].
- 2 Select your desired item on the search result list.
- 5 Returns to the root folder.\*2
- 6 Returns to the upper layer.\*2
- 7 Changes the page to display more items.
- 8 Returns to the previous screen.

\*1 Only for Bluetooth Audio

\*2 Only for USB

# Apps

You can use the Apps installed in your iPhone and Android device by using "Apple CarPlay," "Android Auto," and "USB Mirroring."

- **For iPhone:** You can use **Apple CarPlay** (see the following).
- **For Android device:** You can use **Android Auto** (page 16) and **USB Mirroring** (page 17).

## Preparation:

Make sure that the microphone is connected (page 52).

## Using Apps of iPhone — Apple CarPlay

### About Apple CarPlay

Apple CarPlay is a smarter, safer way to use your iPhone in the car. Apple CarPlay takes the things you want to do with iPhone while driving and displays them on the screen of this unit. You can get directions, make calls, send and receive messages, and listen to the music from iPhone while driving. You can also use Siri voice control to make it easier to operate iPhone.

- For details about Apple CarPlay, visit <https://apple.com/ios/carplay/>.

### Compatible iPhone devices

You can use Apple CarPlay with the following iPhone models.

iPhone 6S, 6S Plus, 7, 7 Plus, 8, 8 Plus, X, XS, XS Max, XR, 11, 11 Pro, 11 Pro Max, SE (1st/2nd generation), 12, 12 mini, 12 Pro, 12 Pro Max, 13, 13 mini, 13 Pro, 13 Pro Max

### Connecting iPhone compatible with Apple CarPlay

See pages 6 to 11.

If two iPhone devices compatible with Apple CarPlay are connected wirelessly, the device recognized first is used for Apple CarPlay. To use the other iPhone, select it on the <Device List> screen.

### Starting Apple CarPlay

Once the wireless setting and connection are done for the first time, the source is automatically changed, and you can use of the Apps of the connected iPhone.

- Unlock your iPhone beforehand.
- You cannot use Apple CarPlay when the screen recording function is enabled on the iPhone.

### To change the source from the others

Touch [**Apple CarPlay**] on the source/option selection screen (page 12).

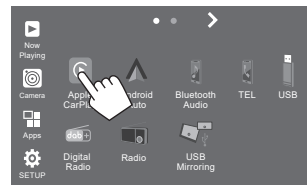

The Apple CarPlay screen is displayed.

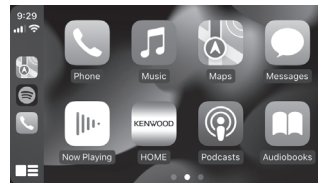

# Apps

## ■ Apple CarPlay screen operation

You can use the Apps of the connected iPhone. The items displayed and the language used on the screen differ among the connected devices.



- 1 Application buttons  
Starts the application.
- 2 Short cut buttons
- 3 [☰] button
  - (Touch) Displays the home screen of Apple CarPlay.
  - (Hold) Activates Siri.
- 4 [HOME] button\*  
Exits the Apple CarPlay screen and displays the Home screen.

\* This icon design may change depending on the iOS version.

## To exit the Apple CarPlay screen

Touch [HOME] on the Apple CarPlay screen, or press HOME button on the monitor panel.

## ■ Using Siri

You can activate Siri while the Apple CarPlay screen is displayed.

On the monitor panel:

- 1 Press the button on the monitor panel.
- 2 Talk to Siri through the microphone.

To deactivate Siri, press the button again.

On the Apple CarPlay screen:

- 1 Touch and hold [☰].
- 2 Talk to Siri through the microphone.

To deactivate Siri, touch [☐☐☐☐].

## Using the Apps of an Android™ device — Android Auto™

### About Android Auto

Android Auto enables you to use features of your Android device convenient for driving. You can easily access route guidance, make calls, listen to music, and access convenient features on the Android device while driving.

- For details about Android Auto, visit <<https://www.android.com/auto/>> and <<https://support.google.com/androidauto>>.

### Compatible Android devices

See page 6.

### Connecting an Android device compatible with Android Auto

See pages 6 to 11.

- If two Android devices compatible with Android Auto are connected wirelessly, the device recognized first is used for Android Auto. To use the other Android device, select it on the <Device List> screen.
- Bluetooth mobile phone currently connected is disconnected when Android device with Android Auto is connected with Bluetooth.

## Starting Android Auto

Selecting **[Android Auto]** on the screen displays the Android Auto screen and enable use of the Apps of the connected Android device.

- Unlock your Android device beforehand.

### Preparation:

Select **[Android Auto]** for the **<Android Mode Select>** setting (page 12).

## To change the source from the others

Touch **[Android Auto]** on the source/option selection screen (page 12).

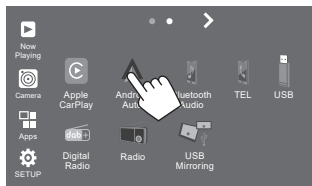

The Android Auto screen is displayed.

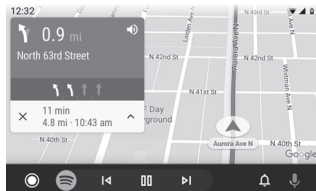

## Operation buttons on the Android Auto screen

You can perform the operations of the Apps of the connected Android device. The items displayed on the screen differ among the connected Android device.

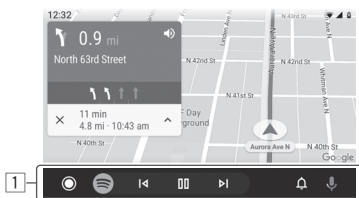

- 1 Application/information buttons  
Starts the application or displays information.

### To exit the Android Auto screen

Press the **HOME** button on the monitor panel.

## Using voice guidance of the Android device

You can activate the voice guidance of the Android device while the Android Auto screen is displayed.

### 1 Press the VOICE button on the monitor panel.

The voice guidance is activated.

### 2 Speak to the microphone to operate the Android device.

**To cancel the voice guidance**, press the  button. Each time you press the button, the voice guidance turns on and off.

## Using the Apps of an Android device — USB Mirroring

**This feature is only used with Android device.**

By installing KENWOOD's Mirroring OA App into your Android device, the screen of the Android device is displayed on the monitor panel of this unit, and you can operate the Android device using the touch panel of this unit.

- For details about KENWOOD's Mirroring, visit <https://www.kenwood.com/cs/ce/>.

### Compatible Android device

Android version 7.0 or later

### Installing KENWOOD's Mirroring OA App

You can obtain "Mirroring OA for KENWOOD" in Google Play.

- Make sure to install the most recent version into your Android device.
- When you use "Mirroring OA for KENWOOD" for the first time, the terms of service are displayed. It is necessary to agree to the terms of service to use this feature.

# Apps

## Connecting an Android device with KENWOOD's Mirroring OA App installed

Connect an Android device with KENWOOD's Mirroring OA App installed via both USB and Bluetooth connection (page 6).

### Starting USB Mirroring

#### Preparation:

- Unlock your Android device beforehand.
- Make sure that the KENWOOD's Mirroring OA App is installed.
- Select [Mirroring for Android] for the <Android Mode Select> setting (page 12).

## 1 Connect the Android device.

- ① Connect the device with Bluetooth.
  - Pair the device with the unit via Bluetooth. See "Pairing a Bluetooth device" on page 7.
  - Select [USB Mirroring] on the profile setting of the <Device List> screen (page 9).
- ② Then, connect the device with USB.

Then follow steps 2 to 4 below on the Android device screen:

## 2 Touch the icon of KENWOOD's Mirroring OA App.

## 3 Touch [OK] to start KENWOOD's Mirroring OA App.

## 4 Touch [Start now] to capture the Android device screen to the screen of this unit.

## 5 Touch [USB Mirroring].

On the source/option selection screen (page 12):

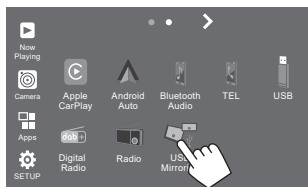

The Android device screen is displayed on the monitor screen of this unit. You can access your Android device from this unit.

### To exit the Android device screen

Press the HOME button on the monitor panel.

# USB

## Playback operations

### Start playing the USB

All files in the USB device will be played repeatedly until you change the source or disconnect the USB device.

#### • When no USB device is connected:

**Connect a USB device to the USB terminal.**

The playback source changes to [USB] and playback starts.

#### • When a USB device is already connected:

**Select [USB] as the source.**

From the Home screen (page 3), touch as follows:

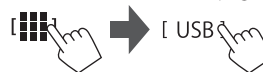

### Playback information and key operation

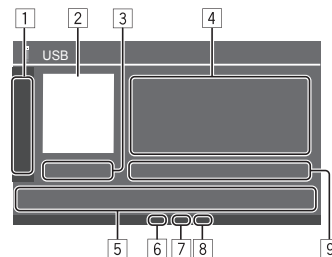

- 1 Displays/hides the following operation keys
- 
- [ ] [ + ] Selects a folder.
- 
- [ ↻ ] Selects repeat playback mode by touching repeatedly.\*
- 
- [ MODE ] Displays the <USB Mode> screen.
- 
- 2 Jacket picture (artwork) is shown if any
- 3 Playing time/playback status
- 4 Content information
- Touching [ < ] scrolls the text if not all of the text is shown.
- 5 Operation keys
- 
- [ 📊 ] Displays the <Equalizer> screen (page 35).
- 
- [ 🔍 ] Displays the search method selection window.
- 
- [ ⏪ ] / [ ⏩ ] • (Touch) Selects a file.  
• (Hold) Reverses/forwards search.
- 
- [ ⏸ ] Starts/pauses playback.
- 
- [ 🎲 ] Selects random playback mode.\*
- 
- 6 Repeat/Random mode indicator
- 7 File type indicator (MUSIC/MOVIE/PICTURE)

- 8 Playlist (PLIST) indicator: displayed when Category List/Link Search is selected.
- 9 Current playback file information (file type/folder no./file no.)
- \* You cannot activate repeat playback mode and random playback mode at the same time.

## Selecting the file type to play

You can specify the file type to play.

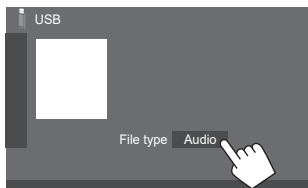

Select the file type as follows:

- [ **Audio** ] Plays back audio files.
- 
- [ **Video** ] Plays back video files.
- 
- [ **Photo** ] Plays back still picture files (Slide Show). You can select the picture to use for display background (see <User Customize> on page 40).

- If the USB contains no files of the selected type, the message "No File" appears. In this case, select the correct file type.

## Video playback operations

While watching a video, you can use the following features.

## Touch screen operations

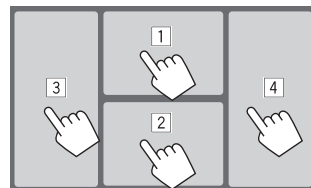

Touching the numbered areas above performs the following actions:

- 1 Displays the video menu control.
- 2 Displays the video source control screen.
- 3 Goes to the previous file.
- 4 Goes to the next file.

## Video menu control

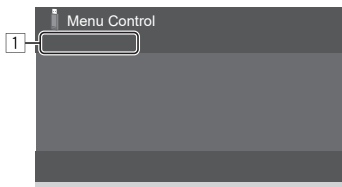

Touching the operation keys performs the following actions:

1

**[Aspect]** Displays the **<Aspect>** screen.  
 • Touch **[Aspect]** to select the aspect ratio.

**<Full>**: For 16:9 original pictures

4:3 signal      16:9 signal



**<Normal>**: For 4:3 original pictures

4:3 signal      16:9 signal



**<Auto>**: The aspect ratio is automatically selected to match the incoming signals.

**[Picture Adjust]** Displays the **<Screen Adjustment>** screen.

- ① Touch **[DIM ON]** or **[DIM OFF]** to turn on or off the dimmer.
- ② Touch **[+]/[-]** to adjust the other items.
  - **<Contrast>**: Adjusts the contrast (-10 to +10).
  - **<Bright>**: Adjusts the brightness (-15 to +15).
  - **<Colour>**: Adjusts the colour (-10 to +10).
  - **<Tint>**: Adjusts the tint (-10 to +10).

## Video source control screen

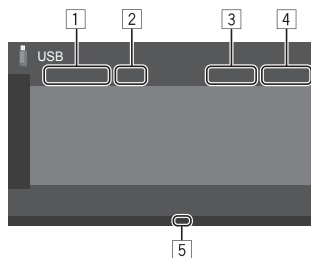

- 1 File type
- 2 Playback status
- 3 Current playback folder no./file no.
- 4 Playing time
- 5 Playback mode indicator (Repeat/Random)

## Search operations

You can search files to play.

### 1 Display the search method selection screen.

On the source control screen:



### 2 Select the search method.

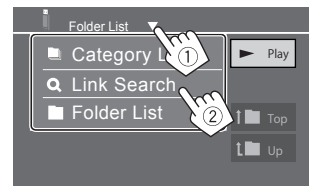

**[Category List]** Search a file by its category (only for audio files).

**[Link Search]** Search a file of the same artist/album/genre with the audio file currently selected.

**[Folder List]** Select a file in the folder list.

### 3 Follow the following procedure for <Category List>, <Link Search> and <Folder List>.

- For list screen operations, see also page 14.



## <Category Search>

This is only used for audio files.

- To change the file type, see page 19.

### 1 Select your desired category.

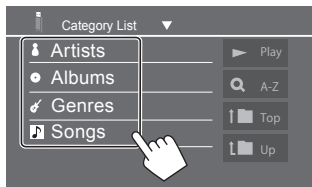

List of the selected category appears.

### 2 Select your desired file on the list.

## <Link Search>

This is only used for audio files.

- To change the file type, see page 19.

### 1 Select the tag information.

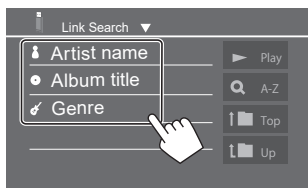

List of the contents containing the same tag with the file currently playing file is displayed.

### 2 Select your desired file on the list.

## <Folder List>

Select the folder, and then the item in the selected folder.

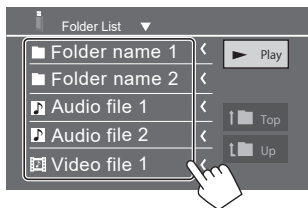

- Touching [**<**] scrolls the text if not all of the text is shown.

## Settings for USB playback

### 1 Display the <USB Mode> screen.

On the source control screen:



### 2 Make the settings.

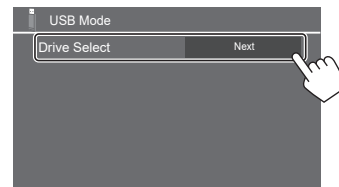

#### <Drive Select>

- **Next:** Switch between internal memory and the memory source of the connected device (such as mass storage device).

# Digital Radio (DAB)

DAB (Digital Audio Broadcasting) is one of the digital radio broadcasting systems available today. It can deliver digital quality sound without any annoying interference or signal distortion. Furthermore, it can carry text and data.

In contrast to FM broadcast, where each programme is transmitted on its own frequency, DAB combines several programmes (called “services”) to form one “ensemble.”

The “Primary component” (main radio station) is sometimes accompanied by a “secondary component” which can contain extra programmes or other information.

## Listening to the radio

The unit switches to DAB alarm scene automatically when receiving an alarm signal from DAB broadcast.

### Select [Digital Radio] as the source.

From the Home screen (page 3), touch as follows:



The last service you selected is tuned in, and the source control screen for the service is displayed.

### Playback information on the source control screen

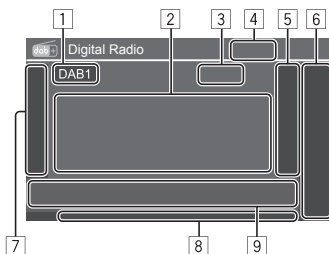

- 1 Selects the band (DAB1/DAB2/DAB3)
- 2 Text information
  - Touching [ < ] scrolls the text if not all of the text is shown.
  - Touching [Now Playing] switches the information and keys between [Next program], [Title], [Artists], [PTY] and [Audio Quality].
- 3 Channel number
- 4 Signal strength
- 5 Displays the preset services window (page 24)
- 6 [P1] – [P5]
  - (Touch) Selects a preset service.
  - (Hold) Presets the current service.

- 7 Displays/hides the following operation keys

[PTY]*	(For RDS features) Enters PTY search mode. ① Touch [PTY]. ② Touch and hold a PTY code to search for. If there is a station broadcasting a programme of the same PTY code as you have selected, that service is tuned in.
[SEEK]	Selects the seek mode for [◀◀]/[▶▶]. <ul style="list-style-type: none"><li>• <b>AUTO1</b>: (Initial): Auto search</li><li>• <b>AUTO2</b>: Tunes in preset services one after another</li><li>• <b>MANU</b>: Manual search</li></ul>

\* Only English/Spanish/French/German/Dutch/Portuguese are available for the text language here. If another language has been selected in <Language> (page 4), the text language is set to [English].

- [TI]** (For RDS features)  
Activates TI Standby Reception mode.
- When TI is activated, the unit is ready to switch to traffic information if available. The TI indicator lights up in white.
  - If the TI indicator lights up in orange, tune in to another service providing Radio Data System signals.
  - The volume adjustment for traffic information is automatically memorised. The next time the unit switches to traffic information, the volume is set to the memorised level.
  - The TI Standby Reception can also be activated or deactivated from "Radio" source control screen. (Page 26)
  - To deactivate, touch **[TI]** again.

**[MODE]** Changes the settings for DAB reception on the **<DAB Mode>** screen.

- [8]** Indicators
- **TI:** Lights up in white when receiving the traffic information, and lights in orange when TI Standby Reception is on standby.
  - **DAB:** Lights up when receiving a DAB broadcast.
  - **DABMC:** Lights up when receiving a DAB multi component.
  - **RDS:** Lights up when receiving a Radio Data System signal.
  - **AUTO1/AUTO2/MANU:** Seek mode indicator
- [9]** Operation keys
- [||||]** Displays the **<Equalizer>** screen (page 35).
- [Q]** Displays the **<Service List>** screen.
- [◀▶]** Searches for a service.
- The search method differs according to the selected seek mode (see Page 22).
- [DLS]**
- Displays Dynamic Label Segment screen (text messages the service sends).

## Selecting a service on the list

You can obtain information on service or select a service to listen to.

### 1 Display the **<Service List>** screen.

On the source control screen, touch as follows:



### 2 Select receive mode.

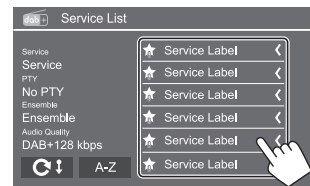

- Touch **[A-Z]** to display the **<A-Z Search>** screen. Then, select the initial to start searching. To search with non-alphabetical characters, touch **[#]**.
- Touch and hold **[↻]** to update the service list.

# Digital Radio (DAB)

## Presetting services in the memory

You can preset five services for each band.

### 1 Select the band, then tune in to a service you want to preset.

On the source control screen, touch as follows:



### 2 Select a preset number to store into.

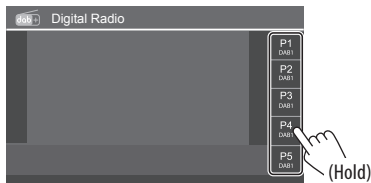

- The service selected in step 1 is stored into the preset number [P1] to [P5] you have selected.

## Selecting a preset service

### 1 Select the band, then display the preset service window.

On the source control screen, touch as follows:

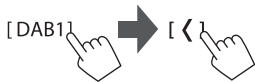

### 2 Select a preset service.

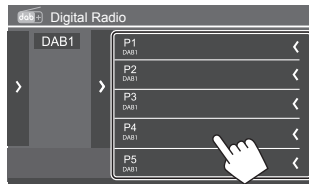

- To show the details of the item, touch [ < ].
- You can also select a preset service by touching [P1] – [P5].

**To hide the window:** Touch [ > ].

## Settings for Digital Radio

### 1 Display the <DAB Mode> screen.

On the source control screen, touch as follows:



### 2 Make the settings.

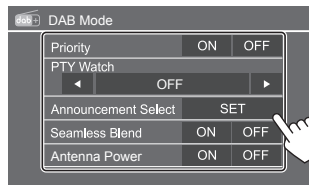

#### <Priority>

- **ON (Initial):** If the same service is provided by Digital Radio during Radio Data System reception, the unit automatically switches to Digital Radio. If the same service is provided by Radio Data System when reception of the service being provided by Digital Radio becomes poor, the unit automatically switches to Radio Data System.
- **OFF:** Deactivates the function.

#### <PTY Watch>

If the service of the set programme type begins with the ensemble being received, the unit switches from any source to Digital Radio for service reception.

- Select the type of programme using [ < ] and [ > ].

#### <Announcement Select>\*1

If the service of the announcement item you activated begins with the ensemble being received, this unit switches from any source to tune in to the service.\*2

- **News flash/Transport flash/Warning/Service/Area weather flash/Event announcement/Special event/Programme Information/Sport report/Financial report**
  - Set [ON] for the announcement items you need.
  - Select [All OFF] to deactivate all the announcements.

#### <Seamless Blend>

- **ON (Initial):** Prevents audio break when switching from Digital Radio to Analog Radio.
- **OFF:** Deactivates the function.

### <Antenna Power>

- **ON** (Initial): Supplies power to the DAB aerial.
- **OFF**: Deactivates the function.

### <Related Service>

- **ON**: When the current selected DAB service network is not available and found the related service, the unit offers to switch to the related service.
- **OFF** (Initial): Deactivates the function.

- \*1 Only English/Spanish/French/German/Italian/Dutch/Portuguese are available for the text language here. If another language has been selected in <Language> (page 4), the text language is set to [English].
- \*2 The volume adjustment while receiving Announcement is automatically memorised. The next time the unit switches to Announcement, the volume is set to the previous level.

# Radio

## Listening to the radio

This unit alarms you emergency when receiving an alarm signal from FM broadcast.

### Select [Radio] as the source.

From the Home screen (page 3), touch as follows:



The last station you selected is tuned in, and the source control screen for the station is displayed.

## Playback information on the source control screen

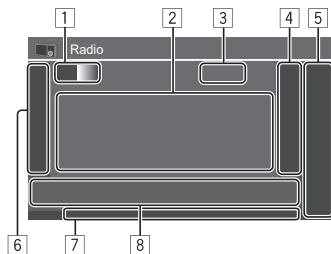

- 1 Selects the band (AM/FM1/FM2/FM3)
    - Each time you touch **[FM]**, FM band changes in order of FM1, FM2, and FM3.
  - 2 Station information area
    - Touching **[<]** scrolls the text if not all of the text is shown.
    - Touching **[Radio Text]** switches between **[Radio Text]**, **[Radio Text Plus]** and **[PTY]**.
  - 3 Current station frequency
  - 4 Displays the preset stations window (page 27)
    - To hide the window, touch **[>]**.
  - 5 **[P1] – [P5]**
    - (Touch) Selects a preset station.
    - (Hold) Presets the current station.
  - 6 Displays/hides the following operation keys
- 
- [AME ↓]** (Hold) Preset the stations automatically.
- 
- [MONO]** (For FM stations) Activates monaural mode for better FM reception (stereo effect will be lost). The MONO indicator lights up.
  - To deactivate, touch **[MONO]** again.

- [TI]** (For FM RDS stations)  
 Activates TI Standby Reception mode.
- When TI is activated, the unit is ready to switch to Traffic Information if available. The TI indicator lights up in white.
  - If the TI indicator lights up in orange, tune in to another station providing Radio Data System signals.
  - The volume adjustment for traffic information is automatically memorised. The next time the unit switches to traffic information, the volume is set to the memorised level.
  - To deactivate, touch **[TI]** again.

**[MODE]** (For FM stations)  
 Change the settings for the selected tuner reception on **<Radio Mode>** screen (Page 27).

- 7** Indicators
- **NEWS:** Lights up when News Standby Reception is activated.
  - **AF:** Lights up when Network-Tracking Reception is activated.
  - **TI:** Lights up in white when receiving the traffic information, and lights in orange when TI Standby Reception is on standby.
  - **LO.S:** Lights up when Local Seek is activated. (page 28).
  - **ST:** Lights up when receiving a stereo broadcast.
  - **MONO:** Lights up when receiving stations in monaural forcibly.

- **RDS:** Indicates the status of the Radio Data System station reception when the Network-Tracking Reception is activated (Page 27).
  - Lights in white: Radio Data System station is being received.
  - Lights in orange: Radio Data System station is not being received.
- **EON:** Lights up when a Radio Data System station detects EON signal.
- **AUTO1/AUTO2/MANU:** Seek mode indicator.

**8** Operation keys

**[||||]** Displays the **<Equalizer>** screen (page 35).

**[PTY]\*** (For FM RDS stations)  
 Enters PTY search mode.

- ① Touch **[PTY]**.
- ② Touch and hold a PTY code to search for.

If there is a station broadcasting a programme of the same PTY code as you have selected, that station is tuned in.

**[SEEK]** Selects the seek mode for **[◀◀]/[▶▶]**.

- **AUTO1** (Initial): Auto search
- **AUTO2:** Tunes in preset stations one after another
- **MANU:** Manual search

**[◀◀]/[▶▶]** Searches for a station.

- The search method differs according to the selected setting for **[SEEK]** (see above).

\* Only English/Spanish/French/German/Dutch/Portuguese are available for the text language here. If another language has been selected in **<Language>** (page 4), the text language is set to **[English]**.

## Presetting stations in the memory

You can preset five stations each for AM and FM1/FM2/FM3.

### Automatic presetting — AME (Auto Memory)

#### 1 Select the band.

On the source control screen:

**[ AM ] / [ FM1 ] — [ FM3 ]**



#### 2 Start AME.

**[ > ]** → **[ AME ]** (Hold)

The local stations with the strongest signals are found and stored automatically.

# Radio

## Manual presetting

### 1 Select the band, and then tune in to a station you want to preset.

On the source control screen:

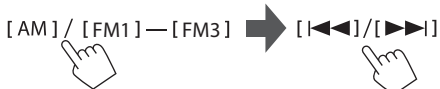

### 2 Select a preset number to store into.



The station selected in step 1 is stored into the preset number [P1] to [P5] you have selected.

## Selecting a preset station

### 1 Select the band, and then display the preset station window.

On the source control screen:

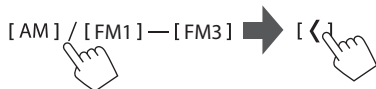

### 2 Select a preset station.

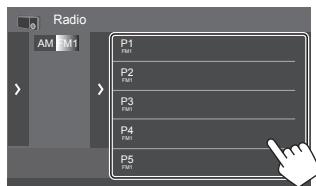

- To show the details of the item, touch [ < ].
- You can also select a preset channel by touching [P1] – [P5].

To hide the window: Touch [ > ].

## Settings for other Radio Data System features

### 1 Display the <Radio Mode> screen.

On the source control screen, touch as follows:



### 2 Make the settings.

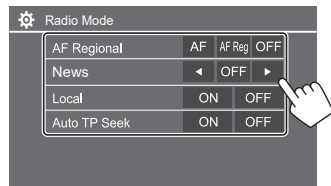

### <AF Regional>

When driving in an area where FM reception is not sufficient enough, this unit automatically tunes in to another FM Radio Data System station of the same network, possibly broadcasting the same programme with stronger signals— Network-Tracking Reception.

Select the reception mode.

- **AF:** Switches to another station. The programme may differ from the one currently received. The AF indicator lights up.
- **AF Reg (Initial):** Switches to another station broadcasting the same programme. The AF indicator lights up.
- **OFF:** Deactivates the function.

Network-Tracking Reception works only while the FM RDS station is received (the RDS indicator lights up).

### <News>\*

- **00min to 90min:** Activates News Standby Reception by selecting the period of time to disable the interruption. The NEWS indicator lights up.
- **OFF (Initial):** Deactivates the function.

**<Local>**

- **ON:** Tunes in only to FM stations with sufficient signal strength. The LOS indicator lights up.
- **OFF (Initial):** Deactivates the function.

**<Auto TP Seek>**

- **ON (Initial):** Automatically searches for a station with better reception for Traffic Information if the reception of the current station is poor.
- **OFF:** Deactivates the function.

\* The volume adjustment for Traffic Information is automatically memorised. The next time the unit switches to Traffic Information, the volume is set to the previous level.

# Other External Components

## AV-IN devices

### ■ Connecting external components

See page 51.

### ■ Using the AV-IN component

#### Preparation:

- Select **[AV-IN]** for the **<AV Input>** setting when connecting the external AV device to the AV-IN terminals (page 42).

#### 1 Select **[AV-IN]** as the source.

From the Home screen (page 3), touch as follows:



- When selecting **[Camera]** for the **<AV Input>** setting (page 42), you cannot select **[AV-IN]**.

#### 2 Turn on the connected component and start playing the source.

### ■ Video menu control

You can display the video menu control while watching the video from the external components.

**Touch the upper portion of the screen.**



The **<Menu Control>** screen appears.

#### **[Aspect]**

Displays the **<Aspect>** setting screen.

- Touch **[Aspect]** to select the aspect ratio.

**<Full>**: For 16:9 original pictures  
4:3 signal      16:9 signal



**<Normal>**: For 4:3 original pictures  
4:3 signal      16:9 signal



#### **[Picture Adjust]**

Displays the **<Screen Adjustment>** screen (page 41).



## Other External Components

### Cameras

Install the cameras (separately purchased) in the appropriate position according to the instructions supplied with the cameras.

#### ■ Connecting a rear view camera

See page 51.

- To use the rear view camera, a reverse lead (REVERSE) connection is required (page 52).
- When connecting the rear view camera, set the <Rear Camera> settings correctly (page 42).

#### ■ Connecting a camera to the AV-IN terminals

See page 51.

- When connecting the external camera to the AV-IN terminals, select [Camera] for the <AV Input> setting (page 42).

**For the rear view camera:** The rear view screen is displayed by shifting the gear to the reverse (R) position when <Rear Camera Interruption> is set to [ON] (page 42).

- A caution message appears on the screen. To remove the caution message, touch the screen.

#### ■ Connecting an around view monitor camera (commercially available)

See page 51.

- To use an Around View Monitor (AVM) camera, connect the AVM unit to the rear view camera input (R-CAM) and AVM terminal.
- For details about AVM features, see the instruction manual supplied with the camera.

#### ■ Watching camera view

##### 1 Display the camera view.

From the Home screen (page 3), touch as follows:



The camera view screen of one of the connected camera is displayed.

##### 2 Change the camera view.

Touch the upper portion of the screen shown below.



- Each time you touch, camera view changes the rear view camera and AV-IN camera alternately.

##### To display parking guide line

(Only for the rear view camera)

Touch the area shown below, or set <Parking Guidelines> to [ON] (page 42).



- To close the parking guidelines, touch the same area again.

##### To exit the camera screen

Press the **HOME** button on the monitor panel or touch the area shown below.



- When the gear is released from the reverse (R) position, the screen also returns to the previous playback source screen.

# Bluetooth® Device

You can use the mobile phone and portable audio player connected through Bluetooth.

- While using Apple CarPlay, Android Auto, or USB Mirroring, use their features for hands-free phones and audio playback. (The Bluetooth device currently connected is disconnected when an iPhone with Apple CarPlay or an Android device with Android Auto is connected.)

## Note

- While driving, do not perform complicated operations such as dialing numbers, using the phone book, etc. When you perform these operations, stop your car in a safe place.
- To use the Bluetooth function, you need to turn on the Bluetooth function of the device.
- Some Bluetooth devices may not be used with this unit depending on the Bluetooth version of the device.
- When a Bluetooth mobile phone is connected, the signal strength and battery level are displayed when the information is acquired from the device.
- If your mobile phone supports PBAP (Phone Book Access Profile), you can display the following items on the touch panel when the mobile phone is connected.
  - Phone book
  - Dialed calls, received calls, and missed calls (up to 100 entries in total)
- Two devices for Bluetooth mobile phone and one for Bluetooth audio can be connected at a time. However, when **[Bluetooth Audio]** is selected as the source, you can connect up to five Bluetooth audio devices and switch between these five devices.

## Bluetooth mobile phone

When a call comes in, this unit automatically enters **[TEL]**, and when it ends, go back to the previous source.

### When a call comes in...

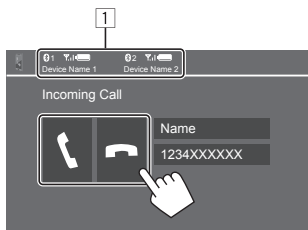

- 1 Phone device information
- Either hands-free phone 1 or 2 is highlighted to indicate which phone is ringing when a call comes in.

Touching the operation keys performs the following actions:

Answers a call.

Rejects a call.

- Call information is displayed if acquired.
- Phone operation is not available while the picture from any camera is displayed.

### During a call...



Touching the operation keys performs the following actions:

Ends a call.

Switches between hands-free mode and phone mode.

**[DTMF]** Enters DTMF (Dual Tone Multi Frequency). You can send a text using the keypad.

**NR LEVEL** Adjusts the noise reduction level.  
[-] / [+] (-5 to 5)

**EC LEVEL** Adjusts the echo volume level.  
[-] / [+] (-5 to 5)

**MIC LEVEL** Adjusts the volume level of the microphone. (-10 to 10)  
[-] / [+]

- Press the VOL ▲/▼ buttons on the monitor panel to adjust the volume of the call or earpiece.

# Bluetooth® Device

## ■ Making a call

### 1 Display the phone control screen.

From the Home screen (page 3), touch as follows:

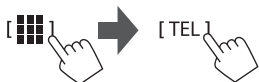

### 2 Select which phone to use if two mobile phones are connected.

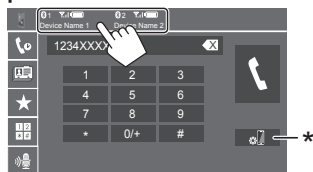

The active device is highlighted.

\* Displays the <Connections SETUP> screen (page 11).

### 3 Select a method to make a call (1 – 5).



- 1 From the call history\* (missed calls/received calls/dialed calls)
- 2 From the phone book\*
- 3 From the preset list (page 32)
- 4 Use direct number entry
- 5 Use voice dialing

\* Applicable only for mobile phone compatible with PBAP (Phone Book Access Profile).

### 4 Select a contact (1), then make a call (2).

• When item 1, 2 or 3 is selected in step 2:

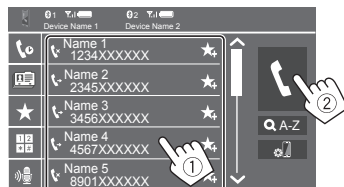

### To use alphabet search in the phone book

- 1 Touch [Q A-Z].
- 2 Touch the first letter you want to search for on the keypad.  
To search for a number, touch [1,2,3...].
- 3 Select a contact you want to call from the list.

### Phone book search results:

“Sort order”, “display order” or any other equivalent settings of the phone may affect and show different search results (page display).

### To display other phone numbers in the same contact

You can store up to ten phone numbers per contact.

- 1 Touch [>].
- 2 Select a contact you want to call from the list.

• When item 4 is selected in step 3:

### Enter the phone number (1), then make a call (2).



- To enter “+”, touch and hold [0/+].
- To delete the last entry, touch [X].

• When item 5 is selected in step 3:

### Say the name of the person you want to call.

- Available only when the connected mobile phone has a voice recognition system.
- If the unit cannot find the target, “Please speak into the microphone” appears. Touch [Start], and then say the name again.
- To cancel voice dialing, touch [Cancel].

## Bluetooth® Device

### ■ Presetting phone numbers

You can preset up to five phone numbers.

#### 1 Display the phone control screen.

From the Home screen (page 3), touch as follows:

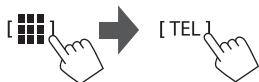

#### 2 Select which phone to use if two mobile phones are connected.

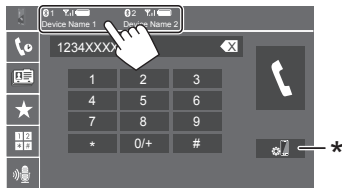

The active device is highlighted.

\* Displays the <Connections SETUP> screen (page 11).

#### 3 Select call history or phone book (1), and then select a contact (2) to preset.

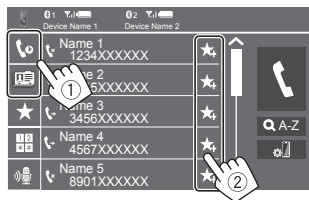

#### 4 Select a preset number to store into.

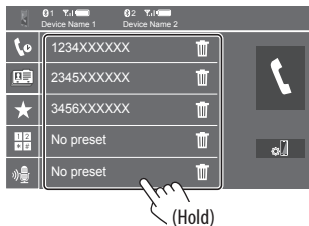

To delete the contact in the preset number: Touch [🗑️] besides the contact on the preset list.

### Bluetooth mobile phone settings

You can change various settings for using Bluetooth devices on the <TEL SET-UP> screen.

#### 1 Display the <TEL SET-UP> screen.

From the Home screen (page 3), touch as follows:



Then, on the <SET-UP> screen, touch as follows:

[System] → <Connections SETUP> : [Enter] → <TEL SET-UP> : [Enter].

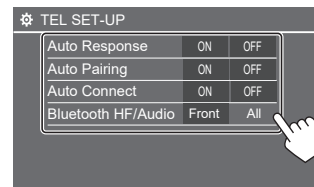

On the <TEL SET-UP> screen, you can change and confirm the following items.

## 2 Make the settings.

### <Auto Response>

- **ON:** The unit answers the incoming calls automatically in 5 seconds.
- **OFF (Initial):** The unit does not answer the calls automatically. Answer the calls manually.

### <Auto Pairing>

- **ON (Initial):** Bluetooth devices are automatically paired.
  - For iPhone with Apple CarPlay and Android device with Android Auto: When the device is connected via USB, it is automatically paired regardless of this setting.
- **OFF:** Cancels. (Not available)

### <Auto Connect>

- **ON (Initial):** Automatically establishes a connection with the already registered Bluetooth device when the unit is turned on.
- **OFF:** Cancels.

### <Bluetooth HF/Audio>

Select the speakers used for Bluetooth mobile phones and Bluetooth audio players.

- **Front Only:** Front speakers only.
- **All (Initial):** All speakers.

## Bluetooth audio player

### Select [Bluetooth Audio] as the source.

From the Home screen (page 3), touch as follows:



The <Bluetooth Audio> screen is displayed.

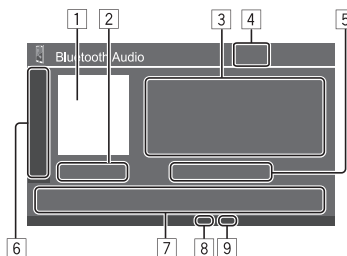

- 1 Jacket picture (artwork) is shown if any
- 2 Playing time/playback status
- 3 Tag data\* (current file title/artist name/album title)
  - Pressing [**<**] scrolls the text if not all of the text is shown.
- 4 Signal strength and battery level  
(Appears only when the information is acquired from the device.)
- 5 Device name
  - Touching the device name shows the <KENWOOD Music Mix> screen (page 34).

- 6 Displays/hides other available operation keys

[**⏮**] Selects random playback mode.

[**🔄**] Selects repeat playback mode by touching repeatedly.

[**⚙️**] Displays the <Connections SETUP> screen (page 11).

- 7 Operation keys

[**📊**] Displays the <Equalizer> screen (page 35).

[**🔍**] Displays the category list.

[**⏮**]/[**⏭**]

- (Touch) Selects a file.
- (Hold) Reverses/forwards search.

[**▶**] Starts playback.

[**⏸**] Pauses playback.

- 8 Repeat mode indicator

- 9 Random mode indicator

\* Available only for devices compatible with AVRCP 1.3.

## ■ Selecting an audio file from the menu

### 1 Display the audio menu.

On the source control screen:



### 2 Select a category (①), and then select a desired item (②).

• For list screen operations, see also page 14.

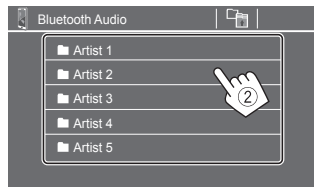
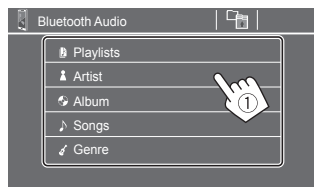

Select an item in each layer until you reach and select the desired file.

## ■ KENWOOD Music Mix

You can connect up to five Bluetooth audio devices at the same time. You can easily switch between these five devices by playing music from the device.

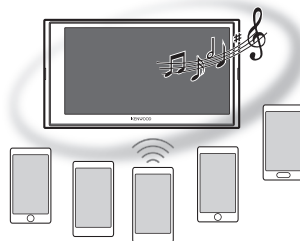

### 1 Display the device list for KENWOOD Music Mix.

On the source control screen:

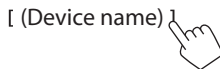

List of the registered devices is displayed.



### 2 Select the device (①) and start playback (②).

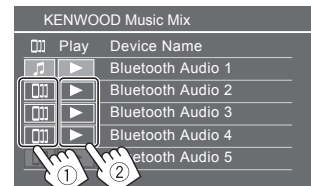

The selected device starts playback.

### The meaning of the icons and their colours:

Icon	Meaning
	Device used currently for <Bluetooth Audio>. <ul style="list-style-type: none"> <li>• Touch to display the &lt;Device List&gt; screen (page 9).</li> </ul>
*	Devices ready for KENWOOD Music Mix. <ul style="list-style-type: none"> <li>• Touch to select the playback device.</li> </ul>
*	Touch to start playing back the selected device. <ul style="list-style-type: none"> <li>• When the playback starts, the background of the icon becomes blue.</li> </ul>

\* When the icon and background colour are gray, the device is not available.

# Settings

## Audio settings

### 1 Display the <Audio> screen.

On the source/option selection screen (page 12):



Then, on the <SET-UP> screen, touch as follows:  
[Audio] (1) → [Enter] for the item you adjust (2).

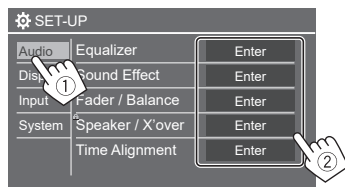

### 2 Adjust the item.

The <Audio> settings are not adjustable;

- When the unit is in standby (STANDBY).
- When the Bluetooth phone is used (making or receiving a call, during a call, or while voice dialling).
- When Apple CarPlay or Android Auto is used for phone calling.

## <Equalizer>

The following adjustments are memorised for each source until you adjust the sound again.

### Selecting a preset sound mode

Select a preset sound mode on the <Equalizer> screen (1).

- **Pop/Easy/Top40/Jazz/Powerful/Rock/Flat** (Initial)/**Bass Boost/User1/User2/User3/User4**

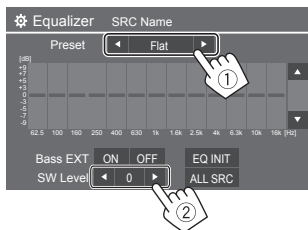

### <SW Level>

Adjusts the subwoofer level (2).

- Not adjustable when <None> is selected for subwoofer on the <Speaker Select> screen (page 37).
- **-50 to +10** (Initial: 0)

**To apply the adjusted equalizer to all playback sources,** touch [ALL SRC], and then touch [OK] to confirm.

## Store your own sound adjustments

- 1 Select one of the User mode (User1 – User4) to store your adjustment into.
- 2 Select a band (1), adjust the level (2), and then adjust the sound (3).

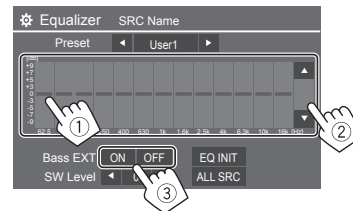

- Repeat 1 and 2 to adjust the level of other bands. Finally adjust the following items.

### <Bass EXT>

Activates/deactivates bass.

- **ON/OFF** (Initial)

**To clear the adjustment,** touch [EQ INIT].

- Once the adjustment screen is closed, your adjustment is memorised.

## Settings

### <Sound Effect>

Adjust the sound effect.

#### <Loudness>

Adjusts loudness.

- OFF (Initial)/Low/High

#### <Bass Boost>

Selects the bass boost level.

- OFF (Initial)/Level 1/Level 2/Level 3

#### <Drive Equalizer>

Reduces the driving noise by raising the bandwidth.

- OFF (Initial)/ON

#### <Space Enhancer>

Virtually enhances the sound space using the Digital Signal Processor (DSP) system (except for Digital Radio and Radio). Select the enhance level.

- OFF (Initial)/Small/Medium/Large

#### <Supreme>

Compensates the sound lost while audio compression process (except for analogue signals).

- OFF/ON (Initial)

#### <Realizer>

Virtually makes the sound more realistic using the Digital Signal Processor (DSP) system. Select the sound level.

- OFF (Initial)/Level 1/Level 2/Level 3

### <Stage EQ>

Moves the centre of the sound to the lower or higher point. Select the height.

- OFF (Initial)/Low/Middle/High

### <Fader/Balance>

Touch [▲]/[▼]/[◀]/[▶] or drag the  mark to adjust.

#### <Fader>

When <X'over Network> is set to [2 way], you can adjust the front and rear speaker output balance.

- F15 to R15 (Initial: 0)

#### <Balance>

Adjusts the left and right speaker output balance.

- L15 to R15 (Initial: 0)

**To clear the adjustment:** Touch [Center].

### <Speaker/X'over>

#### Preparation:

Before making the adjustment for <Speaker/X'over>, select the appropriate crossover network mode according to the speaker system (2-way speaker system or 3-way speaker system).

#### 1 Put the unit in standby.

From the Home screen (page 3), touch as follows:



#### 2 Display the <X'over Network> screen.

Press the VOL ▼ button on the monitor panel and touch the upper right portion on the touch panel at the same time:



#### 3 Select the crossover network mode.

**[2 way]** Select this when 2-way system speakers are used (front/rear/subwoofer).

**[3 way]** Select this when 3-way system speakers are used (tweeter/mid range/subwoofer).

A confirmation message appears. Touch [Yes].



# Settings

Now, you can adjust the <Speaker/X'over> settings.

- 1 Display the <SET-UP> → <Audio> → <Speaker/X'over> screens (page 35).
- 2 Select a car type (①), select the location of the speakers (②)\*, and then display the <Speaker Select> screen (③).

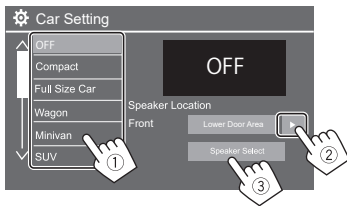

- \* <Speaker Location> is available only when <X'over Network> is set to [2 way].  
<Speaker Location> for rear speakers is only available when the rear speakers are selected for <Speaker Select>.

- 3 Select the speaker type (①), select the size of the selected speaker (②), and then display the <X'over> screen (③).

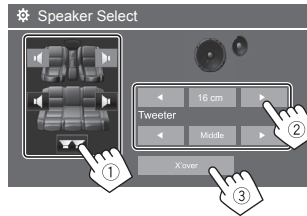

- If a speaker is not connected, select [None].
- When setting the front speakers, select the speaker size for <Tweeter>.

- 4 Adjust the crossover frequency of the selected speaker.

- Adjustable items vary depending on the selected speaker type/speaker size/crossover settings.

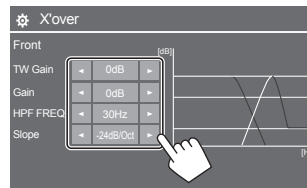

Eg. when adjusting <X'over> for front speakers

## <Gain>/<TW Gain>

Adjusts the output volume of respective speaker.

## <HPF FREQ>/<LPF FREQ>

Adjusts the crossover frequency for respective speaker.

## <Slope>

Adjusts the crossover slope for respective speaker.

## <Phase>

Selects the phase for the speaker.

## <Time Alignment>

This setting improves the sound field for the seats you select.

## <Position>

You can select either <Listening Position> or <Front Focus> on the screen. You cannot use both setting at the same time.

# Settings

## <Listening Position>

This setting is used for both 2-way speaker system and 3-way speaker system.

### 1 Specify your favourite listening position.

- 1 Touch **[Listening Position]**.
- 2 Select the listening position – **[All]** (Initial), **[Front L]**, **[Front R]** or **[Front All]\***.
- 3 Touch **[Adjust]**.

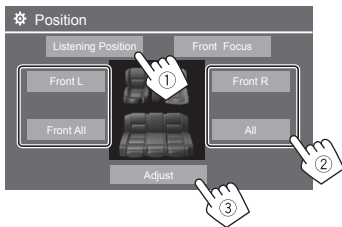

\* [Front All] is selectable only when <X'over Network> is set to [2 way].

### 2 Touch **[Distance]** (1), and then enter the distance from your listening position to each speaker (2).

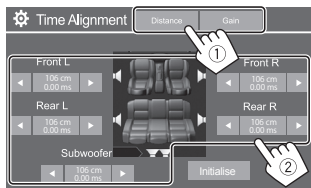

### 3 Touch **[Gain]** (1), and then adjust the sound level of each speaker (2).

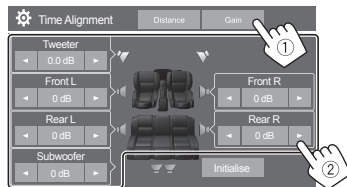

To initialise the setting value: Touch **[Initialise]**.

## Determining the delay time adjustment

If you specify the distance from the centre of your listening position to every speaker, the delay time is automatically computed and set.

Eg. When **[Front All]** is selected as the listening position

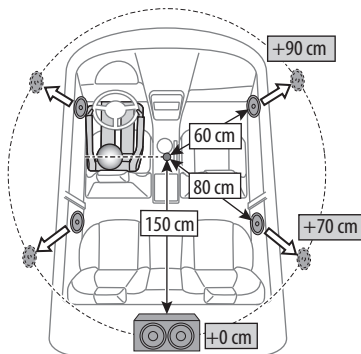

## <Front Focus>

When you select 2-way speaker system, you can use this setting, enabling you to focus the imaginary sound localization for the seat you select.

### 1 Select the listening position.

- 1 Touch **[Front Focus]**.
- 2 Select from **[Front L]**, **[Front R]**, **[Front All (Priority L)]**, **[Front All (Priority R)]**, **[All (Priority L)]**, or **[All (Priority R)]**.
  - "Priority" means to which seats (left or right) the sound localization tends to be shifted.
- 3 Touch **[Adjust]**.

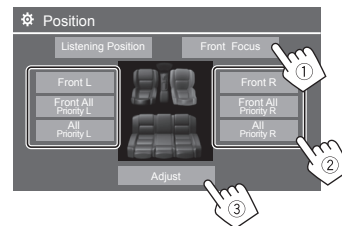

## Settings

### 2 Touch [Distance] (①), and then adjust the following parameters (②).

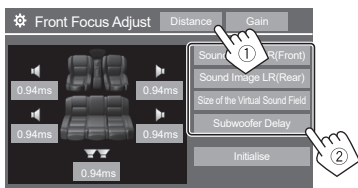

#### [Sound Image LR (Front)]

Locates the sound image in front of the front seats, and adjust the balance.

- You can mute the sounds of the rear speakers and subwoofer.

#### [Sound Image LR (Rear)]

Locates the sound image in front of the rear seats, and adjust the balance.

#### [Size of the Virtual Sound Field]

Adjusts the virtual sound field to the desired field size.

- If the sound image moves out of the front position, adjust [Sound Image LR (Front)]/[Sound Image LR (Rear)].

#### [Subwoofer Delay]

Adjusts the delay time of subwoofer sound.

- To close and finish the parameter setting, touch [Close].

### 3 Touch [Gain] (①), and then adjust the sound level of each speaker (②).

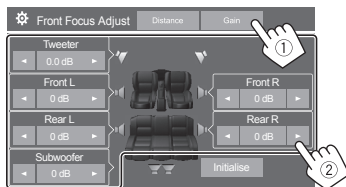

To initialise the setting value: Touch [Initialise].

#### <Volume Offset>

Adjust and store the auto-adjustment volume level for each source.

The volume level will automatically increase or decrease when you change the source.

- **-5 to +5** (Initial: **0**)

## Display settings

### 1 Display the <Display> screen.

On the source/option selection screen (page 12):



Then, on the <SET-UP> screen, touch as follows:

[Display] (①) → [Enter] for the item you adjust or the appropriate setting for the item (②).

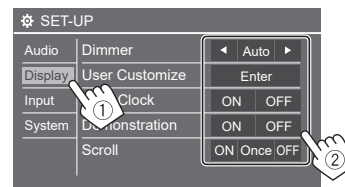

### 2 Adjust the item if more steps are required.

See the respective explanation that follows.

#### <Dimmer>

- **Auto** (Initial): Dims the screen and button illumination when you turn on the headlights.
  - The ILLUMI lead connection is required.
- **ON**: Activates dimmer.
- **OFF**: Deactivates dimmer.

# Settings

## <User Customize>

You can change the following items.

- Background image of the Home screen
- Display background by using your desired still image file (JPEG/24 bit BMP/PNG)
- Illumination colour of the buttons on the monitor panel
- Home screen display pattern

<Background>: Changes the background image of the Home screen.

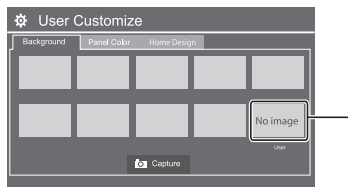

To store your own image into <User>.

<Panel Color>: Changes the illumination colour of the buttons on the monitor panel.

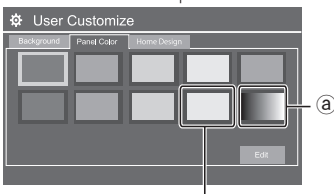

To store your own illumination colour setting into the white-coloured box.

- You can also adjust the illumination colour yourself. Touch the white-coloured box, and then **[Edit]** to display the illumination colour adjustment screen, then select the dimmer setting and adjust the colour. The adjustment is saved in the white-coloured box.
- Selecting **a** changes the illumination colour gradually.

<Home Design>: Changes the display pattern of the Home screen.

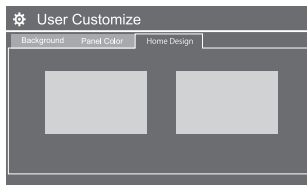

### To store your own scene for <Background>

When using an image file, make sure that the resolution is 800 x 480 pixels.

- You cannot capture copyrighted content and images.
- The colour of the captured image may look different from that of the actual scene.

## 1 While playing Slide Show, display the <User Customize> screen.

- ① Press the **HOME** button on the monitor panel. The Home screen is displayed.
- ② Touch **[Grid]**, and then **[Gear]**. The <SET-UP> screen is displayed.
- ③ Then, on the <SET-UP> screen, touch as follows:  
**[Display] → <User Customize>: [Enter]**

## 2 Display the <Background> screen, and then touch **[Capture]**.

The current still picture is displayed on the screen.

**[Next]** Moves to the following still picture.

## 3 Touch **[Capture]** to capture the image.

A confirmation message appears. Touch **[Yes]** to store the captured image into **[User]**. (The existing image is replaced with the new one.)

- To return to the previous screen, touch **[No]**.
- To cancel the capture, touch **[Cancel]**.

## <OSD Clock>

- **ON (Initial)**: Displays the clock while the screen is off, or while a video source is playing.
- **OFF**: Cancels.

# Settings

## <Demonstration>

- **ON** (Initial): Activates the display demonstration.
- **OFF**: Deactivates the display demonstration.

## <Scroll>

- **ON** (Initial): Scrolls the displayed information repeatedly.
- **Once**: Scrolls the displayed information once.
- **OFF**: Cancels.

Touching [**<**] scrolls the text regardless of this setting.

## <Home Customize>

Changes the playback sources to display on the Home screen (page 3).

- 1 Select the source to replace (①), and then select a new source (②) to display on the Home screen.

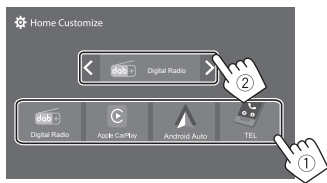

- 2 Repeat step 1 to replace the other playback sources.

## <Screen Adjustment>

Adjust the following items related to the screen. Select [**DIM ON**] (dimmer on) or [**DIM OFF**] (dimmer off), then change the following settings:

### <Contrast>

Adjusts the contrast.

- **-10** to **+10** (Initial: **0** for both dimmer on and off)

### <Bright>

Adjusts brightness.

- **-15** to **+15** (Initial: **0** for dimmer on, and **+15** for dimmer off)

### <Colour>

Adjusts the colour.

- **-10** to **+10** (Initial: **0** for both dimmer on and off)

### <Tint>

Adjusts the tint.

- **-10** to **+10** (Initial: **0** for both dimmer on and off)

## <Viewing Angle>

Select the viewing angle in relation to the monitor to make the image on the screen easier to see.

- **Under 0°** (Initial)/**5°/10°/15°/20°**

## Input settings

- 1 Display the <Input> screen.

On the source/option selection screen (page 12):



Then, on the <SET-UP> screen, touch as follows: [**Input**] (①) → [**Enter**] for the item you adjust or the appropriate setting for the item (②).

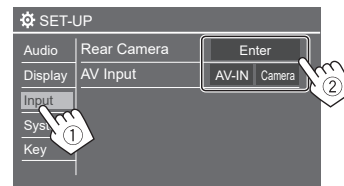

- 2 Adjust the item if more steps are required.

See the respective explanation that follows.

## Settings

### <Rear Camera>

Configure the rear view camera settings.



#### <Rear Camera Interruption>

- **ON** (Initial): Displays the picture from the rear view camera when you shift the gear to the reverse (R) position.
  - A caution message appears on the screen. To remove the caution message, touch the screen.
- **OFF**: Select this when no rear view camera is connected.

#### <Parking Guidelines>\*

- **ON** (Initial): Displays the parking guidelines.
- **OFF**: Hides the parking guidelines.

#### <Guidelines Setup>\*

Adjust the parking guidelines according to the size of the car, parking space and so on. When adjusting the parking guidelines, make sure to use the parking brake to prevent the car from moving. Select the  mark (①), and then adjust the position of the selected  mark (②).

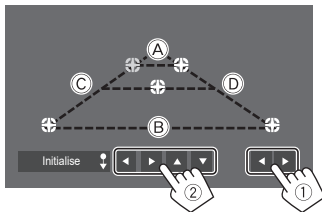

Make sure that ① and ② are horizontally parallel, and that ③ and ④ are the same length.

- Touch and hold [**Initialise** ] for 2 seconds to set all the marks to the initial default position.

#### <Reverse with ATT>\*

- **ON** (Initial): The sound is attenuated while the gear is shifted to the reverse (R) position.
- **OFF**: Not used.

\* When an around view monitor (AVM) is connected, these settings become invalid.

### <AV Input>

Select the usage of the AV-IN input terminal (adjustable only in Standby Mode (page 4)).

- **AV-IN** (Initial): Select this when an external AV device is connected. To watch the connected device, select [**AV-IN**] on the source/option selection screen.
- **Camera**: Select this to watch the view from the connected camera. To watch the camera view, select [**Camera**] on the source/option selection screen.

## System settings

### 1 Display the <System> screen.

On the source/option selection screen (page 12):



Then, on the <SET-UP> screen, touch as follows: [**System**] (①) → [**Enter**] for the item you adjust or the appropriate setting for the item (②).

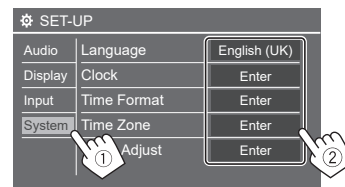

### 2 Adjust the item if more steps are required.

See the respective explanation that follows.

# Settings

---

## <Language>

---

Select the text language used for on-screen information. For details, see page 4.

“Please switch ignition off” appears when the setting is changed. Turn the ignition switch off then on to enable the change.

## <Clock>

---

Set the date and clock adjustment method. For details, see page 5.

## <Time Format>

---

Select the time display format—either **[12-Hour]** or **[24-Hour]** (Initial).

## <Time Zone>

---

Select the time zone for your residential area. For details, see page 5.

## <Clock Adjust>

---

Adjust the date and clock manually. For details, see page 5.

## <Daylight Saving Time>

---

(Not used when the clock is set manually)  
Activate this by selecting the additional time for Daylight Saving Time (if available in your residential area). For details, see page 5.

## <Connections SETUP>

---

Specify or confirm the connected devices information.

### <Device List>

Shows the list of the connected (registered) devices.  
For details, see page 9.

### <PIN Code>

Shows the current PIN code for this unit.  
• This setting is available only when iPhone with Apple CarPlay is not connected.

### <Device Name>

Shows the device name of this unit—**DMX7722DABS**.

### <Bluetooth Device Address>

Shows the Bluetooth device address of this unit.

## <Initialise>

Touch and hold **[Enter]** to reset all settings you have made for using Bluetooth mobile phones and Bluetooth audio players.

## <TEL SET-UP>

Configure settings for using Bluetooth mobile phones.  
For details, see page 32.

- This setting is available only when iPhone with Apple CarPlay is not connected.

## <Wi-Fi Setup>

Shows the device name, device address and password of this unit.

## <Device Audio Control>

Adjust the device sounds. For details, see page 12.

## <Driving Position>

Set your driver's seat position of your car — **[LEFT]** (Initial) or **[RIGHT]**.

This setting changes the sidebar/button position of Apple CarPlay/Android Auto screens accordingly with the driver seat position.

- This setting is available only when iPhone with Apple CarPlay and Android device with Android Auto are not connected.

## Settings

### <Android Mode Select>

Select your Android usage — either **[Android Auto]** (Initial) or **[Mirroring for Android]**.

- This setting is available only in Standby Mode with no device connected via USB.

### <Reset Android Auto Wireless Connection>

Reset the password of Android Auto wireless connection. For details, see page 12.

### <Beep>

This setting is available only when 2-way speaker system is selected (page 36).

- **ON** (Initial): Activates the key-touch tone.
- **OFF**: Deactivates the key-touch tone.

### <SET-UP Memory>

Memorise, recall, or clear the settings you have made.

- The memorised settings are kept even when the unit is reset.
- Available only when **<SET-UP Memory>** is set to **[Unlock]** (selected initially).

Touch **[Yes]** to display the setting screen, then select an operation:

- **Recall**: Recalls the memorised settings.
- **Memory**: Memorises the current settings.
- **Clear**: Clears the currently memorised settings and return to the factory (Initial) settings.
- **Cancel**: Cancels.

A confirmation message appears. Touch **[Yes]**.

You can also set to lock the **<SET-UP Memory>** from being changed. Touch **[Lock]** to lock the settings.

- Some items in **<SET-UP>** menu, eg. **<Speaker/X'over>**, cannot be adjusted when **[Lock]** is selected.

### <Initialise>

Initialise all settings you have made. Touch and hold **[Enter]** to initialise the settings.

- After initializing the settings, adjust the settings on the **<Initial Setup>** screen.

### <Serial Number>

Displays the serial number.

### <Steering Remote Controller>

Assign the functions to the keys on the remote controller on the steering wheel.

- This function is available only when your car is equipped with the electrical steering remote controller.
- You can only register/change the functions while you are parked.
- If your steering remote controller is not compatible, learning may not be completed and an error message may appear.
- For connection, see page 51 for more information.

- 1 Touch [SET] for <Steering Remote Controller> to display the setting screen.**
- 2 Press and hold a button on the steering remote controller to register.**
- 3 Select a function to assign to the selected button.**

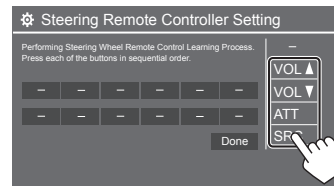



## Settings

**4 Repeat steps 2 and 3 to register other buttons.**

**5 Touch [Done] to finish the procedure.**

- The unit can register all of the buttons' functions at the same time. To do this, press all buttons in turn and after pressing all of them, touch **[Done]** on the **<Steering Remote Controller Setting>** screen. However, new functions cannot be learned after this operation.

**To change the previously assigned function:**

- ① Touch the key to change on the **<Steering Remote Controller Setting>** screen.
- ② Select a new function to assign from the function list.
- ③ Touch **[Done]** to finish the procedure.

**To initialise the setting:** Touch **[Initialise]** for **<Steering Remote Controller>**.

A confirmation message appears. Touch **[Yes]**.

- To cancel the initialisation, touch **[No]**.

### <System Information>

Update the system by connecting a USB device containing an update file.

- To obtain the update file, visit <https://www.kenwood.com/cs/ce/>.

Connect a USB device with the update file to the unit.

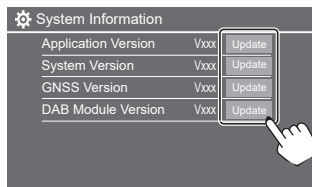

Update starts. It may take a while. If the update has been completed successfully, "Update Completed. Please switch ignition off" appears.

#### <Application Version>

Updates the system application.

#### <System Version>

Updates the system.

#### <GNSS Version>

Updates the Global Navigation Satellite firmware.

#### <DAB Module Version>

Updates the Digital Audio Broadcast (DAB) module application.

- Do not disconnect the USB device while updating.
- If the update has failed, turn the ignition switch off then on, and retry the update.

### <Open Source Licenses>

Shows the Open Source Licenses.

# Remote Controller

To use the remote controller, purchase optional remote controller, KCA-RCDV340.

- When using the remote controller, refer also to the instruction manual supplied with the remote controller.

Remote sensor\*

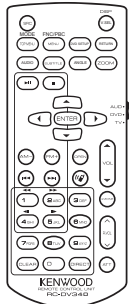
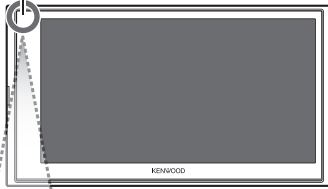

\* DO NOT expose the remote sensor to bright light (direct sunlight or artificial lighting).

KCA-RCDV340

## CAUTION

- Do not leave the remote controller in hot places such as on the dashboard.
- Risk of the fire of explosion if the battery is replaced by an incorrect type. Ensure to replace only with the same type.
- Risk of fire, explosion or the leakage of flammable liquid or gas if the battery is left in an extremely high temperature surrounding environment and/or subjected extremely low air pressure. The battery pack or batteries shall not be exposed to excessive heat such as sunshine, fire or the like.
- Risk of fire, explosion or the leakage of flammable liquid or gas if the battery is disposed into fire or a hot oven, recharged, shorted, mechanically crushed or cut of the battery.
- If spilled fluid comes in contact with your eyes or on clothing, immediately rinse with water and consult a physician.

## Preparation

### Battery installation

Use two "AAA"/"R03"-size batteries.

Insert the batteries with the + and - poles aligned properly, following the illustration inside the case.

- Always insert batteries from - poles to avoid bending the springs.
- If the Remote Controller operates only over shorter distances or does not operate at all, it is possible that the batteries are depleted. In such instances, replace both batteries with new ones.

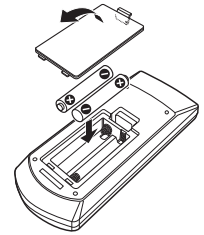

### Remote Controller mode switch

The functions operated from the remote controller differ depending on the position of the mode switch.

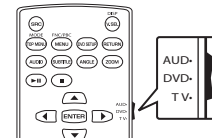

- **AUD mode:** Switch to this mode when controlling a selected source or tuner source, etc.
- **DVD mode:** Not used.
- **TV mode:** Not used.

# Remote Controller

## Basic operations for KCA-RCDV340

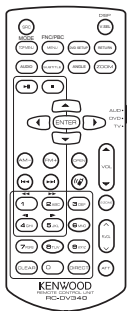

### Common operations

<b>SRC</b>	<ul style="list-style-type: none"> <li>• Selects the source.</li> <li>• Hangs up the incoming/current call.</li> </ul>
<b>VOL ▲/▼</b>	Adjusts the volume level.
<b>ATT</b>	Attenuates/restores the sound.
<b>☎</b>	Answers incoming calls.
<b>FNC/PBC/MENU</b>	Switches the control screen of source.
<b>MODE/TOP MENU</b>	Changes the aspect ratio. <ul style="list-style-type: none"> <li>• The aspect ratio changes each time you press this key.</li> </ul>
<b>V.SEL</b>	Not used for this unit.

<b>ENTER</b>	Not used for this unit.
<b>DVDSETUP</b>	Not used for this unit.
<b>RETURN</b>	Not used for this unit.
<b>AUDIO</b>	Not used for this unit.
<b>SUBTITLE</b>	Not used for this unit.
<b>ANGLE</b>	Not used for this unit.
<b>ZOOM</b>	Not used for this unit.
<b>OPEN</b>	Not used for this unit.
<b>2 ZONE</b>	Not used for this unit.
<b>R.VOL </b>	Not used for this unit.
<b>CLEAR</b>	Not used for this unit.

### Audio file/Video file/Picture file

<b>FM+ / AM-</b>	Selects a folder.
<b>◀◀ / ▶▶</b>	Selects a file.
<b>▶  </b>	Starts/pauses playback.

### Digital Radio/Radio

<b>FM+ / AM-</b>	Digital Radio: Selects the band (FM+). Radio: Selects the band.
<b>◀◀ / ▶▶</b>	Searches for services/stations.*
<b>▶  </b>	Switches the seek mode.

\* The search method differs according to the selected seek mode.

<b>0 - 9</b>	<ul style="list-style-type: none"> <li>• Specifies preset number for Radio. (1-5)</li> <li>• Specifies preset service for DAB. (1-5)</li> <li>• Specifies the frequency of the station to receive to search for in direct search.</li> </ul>
--------------	--

<b>DIRECT</b>	Enters direct search mode.
---------------	----------------------------

### USB

<b>FM+ / AM-</b>	Selects a folder.
<b>◀◀ / ▶▶</b>	Selects a file.
<b>▶  </b>	Starts/pauses playback.

### Searching for a station directly

While listening to the radio, you can search for a station frequency directly using the number buttons.

- 1 Press DIRECT to enter the search mode.**
- 2 Press a number button to select a desired station frequency.**
  - To confirm the selection, press ◀◀ / ▶▶.

**To exit the search mode:** Press **DIRECT**.

# Installation and Connection

This section is for the professional installer. For safety's sake, leave wiring and mounting to professionals. Consult the car audio dealer.

## WARNINGS

- DO NOT connect the ignition wire (red) and the battery wire (yellow) to the car chassis (ground), you may cause a short circuit, that in turn may start a fire.
- DO NOT cut out the fuse from the ignition wire (red) and the battery wire (yellow). The power supply must be connected to the wires via the fuse.
- Always connect the ignition wire (red) and the battery wire (yellow) to the power source running through the fuse box.

## CAUTIONS

- Install this unit in the console of your car.
- Do not touch the metal parts of this unit during and shortly after the use of the unit. Metal parts such as the heat sink and enclosure become hot.

## Before installation

### Precautions on installation and connection

- Mounting and wiring this product requires skills and experience. For best safety, leave the mounting and wiring work to professionals.
  - Mount the unit so that the mounting angle is 30° or less.
  - Make sure to ground the unit to a negative 12 V DC power supply.
  - Do not install the unit in a location exposed to direct sunlight or excessive heat or humidity. Also avoid places with too much dust or the possibility of water splashing.
  - Do not use your own screws. Use only the screws provided. If you use the wrong screws, you could damage the unit.
  - After the unit is installed, check whether the brake lamps, blinkers, wipers, etc. on the car are working properly.
  - Do not press hard on the panel surface when installing the unit to the car. Otherwise scratches, damage, or failure may result.
  - If the power is not turned on ("Miswiring DC Offset Error", "Warning DC Offset Error" is displayed), the speaker wire may have a short circuit or have touched the chassis of the car and the protection function may have been activated. In this case, the speaker wire should be checked.
  - Keep all cables away from heat dissipating metal parts.
- If your car's ignition does not have an ACC position, connect the ignition wires to a power source that can be turned on and off with the ignition key. If you connect the ignition wire to a power source with a constant voltage supply, such as with battery wires, the battery may be drained.
  - If the fuse blows, first make sure the wires are not touching to cause a short circuit, then replace the old fuse with one with the same rating.
  - Insulate unconnected wires with vinyl tape or other similar material. To prevent a short circuit, do not remove the caps and do not let the cable out at the ends of the unconnected wires or the terminals.
  - Secure the wires with cable clamps and wrap vinyl tape around the wires that comes into contact with metal parts to protect the wires and to prevent short circuit.
  - Connect the speaker wires correctly to the terminals to which they correspond. The unit may be damaged or fail to work if you share the ⊖ wires or ground them to any metal part in the car.
  - When only two speakers are being connected to the system, connect both connectors either to the front output terminals or to the rear output terminals (do not mix front and rear). For example, if you connect the ⊕ connector of the left speaker to a front output terminal, do not connect the ⊖ connector to a rear output terminal.

## Installation and Connection

### Parts list for installation

**Note:** This parts list does not include all the package contents.

- 1 Wiring harness (× 1)
- 2 Extension wire, 2 m (× 1)
- 3 Microphone, 3 m (× 1)
- 4 Trim plate (× 1)
- 5 Mounting sleeve (× 1)
- 6 Extraction keys (× 2)
- 7 GPS aerial, 3.5 m (× 1)
- 8 Metal plate (× 1)

### Installation procedure

- 1 Remove the key from the ignition and disconnect the  $\ominus$  battery.
- 2 Make the proper input and output wire connections for each unit.
- 3 Connect the speaker wires of the wiring harness.
- 4 Take Connector B on the wiring harness and connect it to the speaker connector in your vehicle.
- 5 Take Connector A on the wiring harness and connect it to the external power connector in your vehicle.
- 6 Connect the wiring harness to the unit.
- 7 Install the unit in your car.  
Make sure that the unit is installed securely in place.  
If the unit is unstable, it may malfunction (eg., the sound may skip).
- 8 Reconnect the  $\ominus$  battery.
- 9 Initialise the unit (page 44).
- 10 Configure <Initial Setup> (page 4).

### Installing the unit

#### Installing the unit using the mounting sleeve

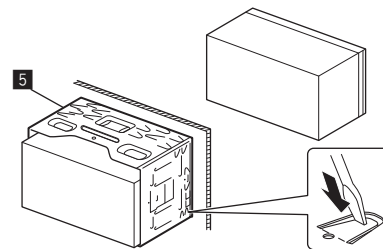

Bend the tabs of the mounting sleeve with a screwdriver or similar utensil and attach it in place.

#### Installing the trim plate

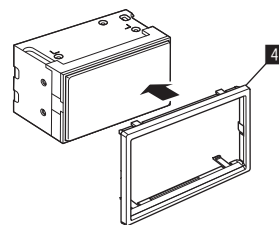

## Installation and Connection

### Removing the unit

- 1 Remove the trim plate (4) by inserting the two extraction keys (6) as illustrated.

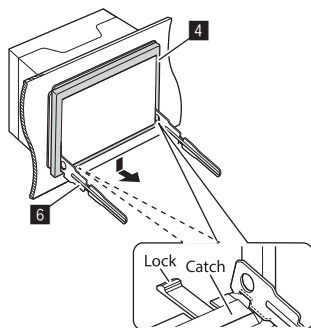

- 2 When the lower level is removed, remove from the upper two catches of the trim plate (4).

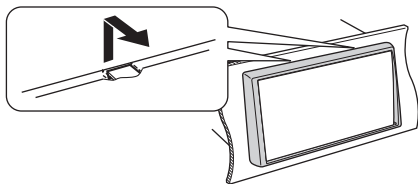

The frame can be removed from the top side in the same manner.

- 3 Insert the extraction keys (6) deeply into the slots on each side.

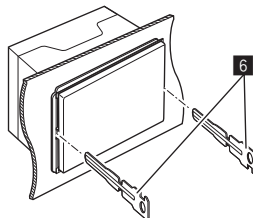

- 4 Lower the extraction keys (6) toward the bottom, and pull out the unit halfway while pressing towards the inside.

Be careful to avoid injury from the catch pins on the extraction key.

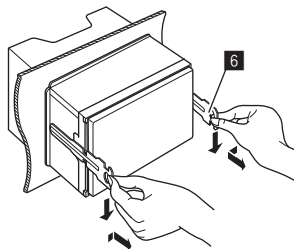

- 5 Pull the unit all the way out with your hands, being careful not to drop it.

### Installing the supplied GPS aerial

GPS aerial is installed inside of the car. It should be installed as horizontally as possible to allow easy reception of the GPS satellite signals.

- 1 Clean your dashboard or other surface.
- 2 Remove the separator of the metal plate (8).
- 3 Press the metal plate (8) down firmly on your dashboard or other mounting surface.
- 4 Remove the separator of the GPS aerial (7), and stick the aerial to the metal plate (8).

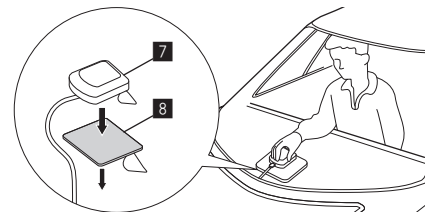

## Installation and Connection

### Notes on using the supplied GPS aerial (7)

- Use the supplied GPS aerial (7). Using the GPS aerial other than the supplied one may cause a drop in positioning accuracy.
- Depending on the type of car, reception of the GPS satellite signals might not be possible with an inside installation.
- Please install the supplied GPS aerial (7) in an area away from any aerials that are used with CB radios or satellite televisions.
- The supplied GPS aerial (7) should be installed at a position that is spaced at least 30 cm from cellular phone or other transmitting aerial. Signals from the GPS satellite may be interfered with by these types of communication.
- Painting the supplied GPS aerial (7) with (metallic) paint may cause a drop in performance.

### Connecting external components

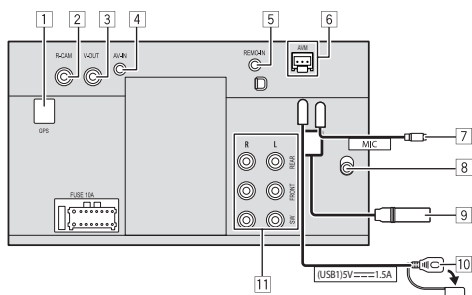

- 1 GPS aerial input (GPS)
- 2 Rear view camera input (R-CAM)
- 3 Video output (V-OUT)
- 4 Audio video input (AV-IN)

Connect the following type of 4-pole mini plug:

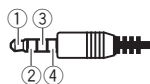

- 1 Left audio
- 2 Right audio
- 3 Ground
- 4 Composite video

- 5 Steering wheel remote input (REMO-IN)
  - Connect to the car's steering remote harness using the steering wheel remote input cable. Contact your KENWOOD dealer for details.
- 6 Around View Monitor terminal (AVM)
  - Connect an around view monitor (commercially available). For details on connections, refer to the instructions manual supplied with the around view monitor.
- 7 Microphone input (MIC) (page 52)
- 8 DAB aerial input
  - Connect a DAB aerial (separately purchased).
- 9 Aerial terminal
- 10 USB terminal
- 11 Output terminals\*
  - Left output (White)
  - Right output (Red)

REAR: Rear speaker preouts  
FRONT: Front speaker preouts  
SW: Subwoofer preouts

#### For 3-way crossover:

REAR: Tweeter preouts  
FRONT: Mid range speaker preouts  
SW: Subwoofer preouts

- \* When connecting an external amplifier, connect its ground wire to the chassis of the car; otherwise the unit may be damaged.

# Installation and Connection

## Wiring connection

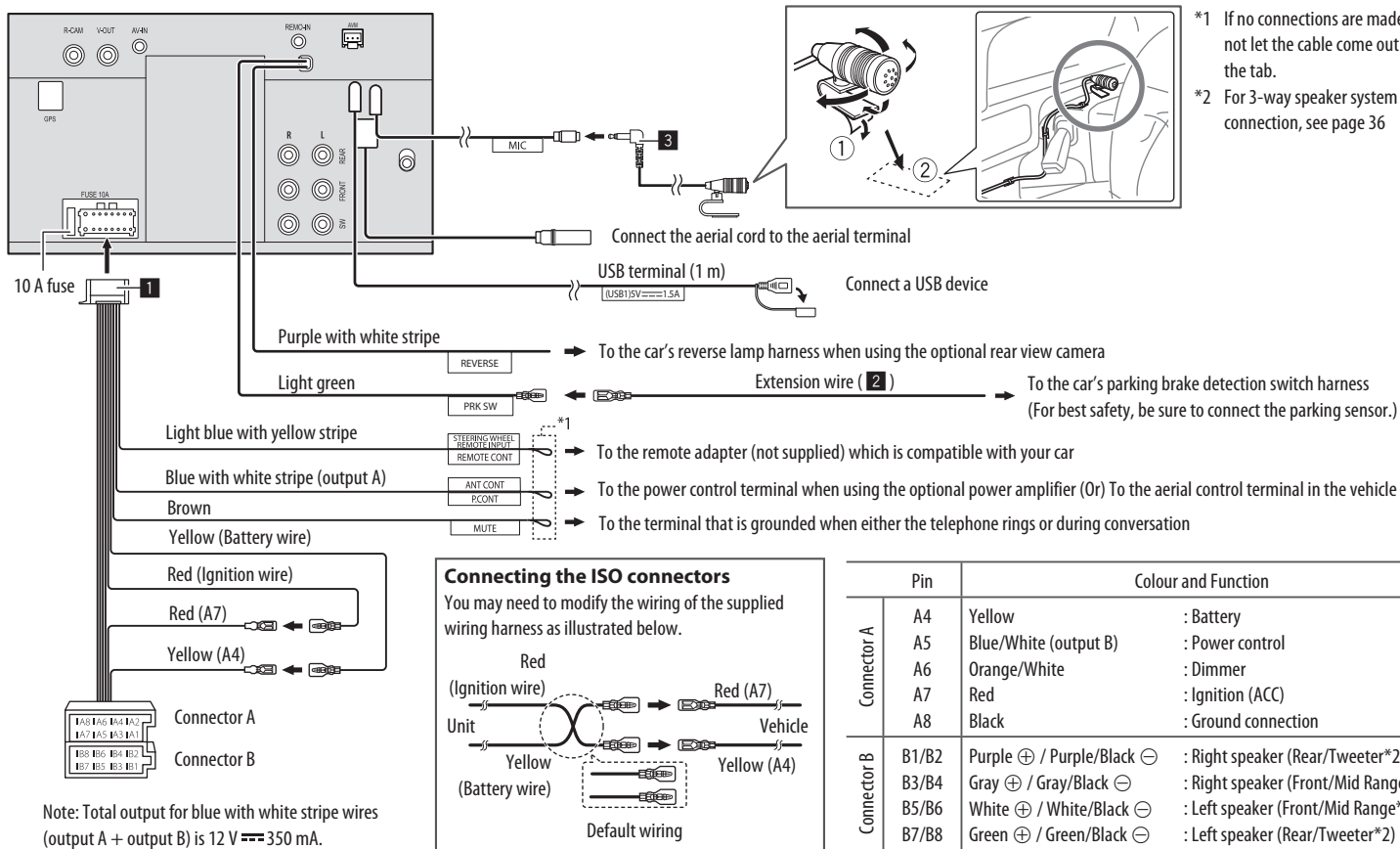

\*1 If no connections are made, do not let the cable come out from the tab.

\*2 For 3-way speaker system connection, see page 36



# References

## Maintenance

### Cleaning the unit

- Do not use any solvent (for example, thinner, benzine, etc.), detergent, or insecticide. This may damage the monitor or the unit.
- Gently wipe the panel with a soft, dry cloth.

## More information

### About USB playback

#### Important

Make sure all important data has been backed up to avoid losing the data. We bear no responsibility for any loss of data stored in the devices while using this unit.

#### Notes on using a USB device

- Avoid using the USB device if it might affect driving safety.
- When connecting with a USB cable, use a USB 2.0 cable.
- Electrostatic shock at connecting a USB device may cause abnormal playback of the device. In this case, disconnect the USB device, and turn off then on this unit.
- Do not pull out and connect the USB device repeatedly while "Reading" is shown on the screen.
- Operation and power supply may not work as intended for some USB devices.
- Do not leave a USB device in the car, or expose to direct sunlight or high temperatures to prevent deformation or damage to the device.

### Playable files

- This unit can play back the following files with following codec and extension code:
  - **Audio files:** MP3 (.mp3), WMA (.wma), WAV (.wav), AAC (.m4a), FLAC (.flac)
  - **Picture files:** JPEG (.jpg, .jpeg)/PNG (.png)/24 bit BMP (.bmp)
  - **Video files:** MPEG1, 2 (.mpg, .mpeg)/MPEG4 (.mp4)/H.264 (.h264)/MNV (.mwn)/MKV (.mkv)

### Audio file conditions

- This unit can play back files that meet the conditions below:
  - Bit rate:
    - MP3: MPEG1 Audio Layer 3: 32 kbps – 448 kbps
    - MPEG2 Audio LSF Layer: 32 kbps – 384 kbps
    - WMA: Up to 320 kbps
    - AAC: Max 288 kbps per channel/48 kHz
  - Bit number:
    - WAV: 4 bits – 32 bits
    - FLAC: 4 bits – 32 bits
  - Sampling frequency:
    - MP3: MPEG1 Audio Layer 3: 32 kHz – 48 kHz
    - MPEG2 Audio LSF Layer: 16 kHz – 24 kHz
    - WMA: 8 kHz – 48 kHz
    - AAC: 8 kHz – 96 kHz
    - WAV: 44.1 kHz – 192 kHz
    - FLAC: 8 kHz – 192 kHz
  - Files recorded in VBR (variable bit rate), and have a discrepancy in elapsed time indication.

- This unit can show or display the following Tag:
  - MP3: ID3 Tag (version 1.0/1.1/2.2/2.3/2.4)
  - WMA Tag
  - WAV Tag
  - AAC Tag
  - FLAC Tag
  - Jacket picture (artwork):
    - Data size: less than 500 KB
- This unit cannot play back the following files:
  - MP3 files encoded with MP3i and MP3 PRO format.
  - MP3 files encoded with Layer 1/2.
  - WMA files encoded with lossless, professional, and voice format.
  - WMA files which are not based upon Windows Media® Audio.
  - WMA/AAC files copy-protected with DRM

## References

### Video file conditions

- Streams that conform to:
  - MPEG1/MPEG2:  
Audio: MP1, MP2, MP3, AAC-LC, AC3, LPCM  
Video: MPEG1, MPEG2
  - MPEG4:  
Audio: MP3, AAC  
Video: MPEG4
  - H.264:  
Audio: MP3, AAC  
Video: H.264
  - MKV:  
Audio: MP3, AC3, LPCM, AAC-LC/HE, AAC, Cook  
Video: H.264, MPEG-4 AVC, MPEG4, WMV
  - WMV:  
Audio: WMA  
Video: Windows Media Video 9
- Maximum bit rate:
  - MPEG1: Max 4 Mbps
  - MPEG4/H.264/WMV: Max 8 Mbps
- Picture size
  - MPEG1: 176 x 144 , 352 x 240 , 720 x 480 (30fps)
  - MPEG2: 176 x 144, 352 x 288, 320 x 240, 720 x 480, 720 x 576, 1 440 x 1 080, 1 280 x 720, 1 920 x 1 080, 1 280 x 720
  - H.264: 1 920 x 1 080 (30fps)
  - WMV: 1 280 x 720 (60fps), 1 920 x 1 080 (30fps)
  - MPEG4: 1 920 x 1 080 (30fps)

- Other playable conditions:
  - Video file size: Less than 2 GB
  - MPEG1/MPEG2: File format: SP@LL, SP@ML, MP@LL, MP@ML, MP@H-14, MP@HL, HP@LL, HP@ML, HP@H-14, HP@HL

### Folder/file limitations

This unit can recognize:

- A total of 5 000 files
- 250 folders each for video files/photo files and a maximum of 999 files per folder
- The maximum number of characters is 260 characters for folder name plus file name (when the characters are 1 byte).

### Unplayable USB device

- This unit may not play back files in a USB device properly when using a USB extension cable.
- USB devices equipped with special functions such as data security functions cannot be used with the unit.
- Do not use a USB device with nine or more partitions.
- Depending on the shape of the USB devices and connection ports, some USB devices may not be attached properly or the connection might be loose.
- This unit may not recognize a memory card inserted into a USB card reader.

### About Apple CarPlay

- The following iPhone devices can be used.  
Made for
  - iPhone 6S, 6S Plus, 7, 7 Plus, 8, 8 Plus, X, XS, XS Max, XR, 11, 11 Pro, 11 Pro Max, SE (1st/2nd generation), 12, 12 mini, 12 Pro, 12 Pro Max, 13, 13 mini, 13 Pro, 13 Pro Max
- The GPS aerial must be connected to use Apple CarPlay wirelessly with Wi-Fi.
- Although the service area is expanding, Apple CarPlay service is NOT available in some markets. Please check the latest information concerning availability in your region from the below website.
  - <http://www.apple.com/ios/feature-availability/#applecarplay-applecarplay>

### About Android Auto

- Although the service area is expanding, Android Auto service is NOT available in some markets. Please check the latest information concerning availability in your region from the below website.
  - <https://support.google.com/androidauto/>

### ■ About USB Mirroring

- Depending on the connected Android device, you may need to enable virtual keyboard setting on your smartphone to display software keyboard on the screen of this unit and on your Android device.
- The audio may be of poor quality, interrupted or skipped, depending on several conditions such as network condition, the application and etc.
- If you perform pairing with another device during mirroring, mirroring (audio and/or video) will be disturbed or paused.
- Some Apps may not support audio sharing (no sound from the background playback source).
- Some operations may not work depending on the compatibility between this unit, "Mirroring OA for KENWOOD App" and your Android device.

## Troubleshooting

---

What appears to be trouble is not always serious. Check the following points before calling a service centre.

- For operations with external components, refer also to the instructions supplied with the adapters used for connection (as well as the instructions supplied with the external components).

### General

---

#### **No sound comes out of the speakers.**

- Adjust the volume to the optimum level.
- Check the cords and connections.

#### **No picture is displayed on the screen.**

- Turn on the screen (page 4).

#### **The unit does not work at all.**

- Initialise the unit (page 44).

#### **The remote controller does not work.**

- Replace the battery.

#### **"No Signal"/"No Video Signal" appears.**

- Start playback on the external component connected to this unit.
- Check the cords and connections.
- Signal input is too weak.

#### **"Miswiring DC Offset Error"/"Warning DC Offset Error" appears.**

- A speaker cord has shorted or it has come into contact with the car chassis. Wire or insulate the speaker cord as appropriate, turn the ignition switch off then on.

#### **"Parking off" appears.**

- No playback picture is shown when the parking brake is not engaged.

### Bluetooth connection

---

#### **The Bluetooth device does not detect this unit.**

- Turn off, then turn on the Bluetooth device.
- Turn off, then turn on this unit.

#### **This unit does not pair with the Bluetooth device.**

- If the device is connected via USB cable, disconnect it, and retry.
- Turn off, then turn on the Bluetooth device.

#### **The device is disconnected automatically or the device cannot be connected.**

- When iPhone compatible with Apple CarPlay is connected to the USB terminal, it cannot be connected via Bluetooth. Use the phone and audio player function on the Apple CarPlay screen.
- When an Android device compatible with Android Auto is connected to the USB terminal, the device is connected via Bluetooth automatically, and the Bluetooth mobile phone currently connected is disconnected.

## Troubleshooting

### The Bluetooth connection between the Bluetooth device and the unit is unstable.

- Delete the unused registered Bluetooth device from the unit (page 11).

### “Connection Error” appears.

- The device is registered but the connection has failed. Connect the registered device using the <Device List> screen (page 10).

### “Please Wait...” appears.

- The unit is preparing to use the Bluetooth function. If the message does not disappear, turn off and turn on the unit, then connect the device again.

### “Initialise Error” appears.

- The unit has failed to initialise the Bluetooth module. Try the operation again.

## Apps

### Apple CarPlay:

#### [Apple CarPlay] is not highlighted on the source/option selection screen.

- Check the version of the connected iPhone—whether it is compatible with Apple CarPlay.
- Check the iPhone is connected properly for Apple CarPlay. You can check the connection referring to the <Device List> screen.

### Sound is too loud or small while using Apple CarPlay.

- Adjust <Guidance/Voice Recognition Volume>, <Phone Incoming Volume>, <Phone Calling/Talking Volume> or <Media Volume> for <Apple CarPlay> (page 12).

### The Home screen appears while using Apple CarPlay.

- Wi-Fi is disconnected.

### Android Auto:

#### [Android Auto] is not highlighted on the source/option selection screen.

- Check whether [Android Auto] is selected in the <Android Mode Select> (page 44).
- Check the version of the connected Android device — whether it is compatible with Android Auto.
- Check the Android device is connected properly for Android Auto. You can check the connection referring to the <Device List> screen.

### The Home screen appears while using Android Auto.

- Wi-Fi is disconnected.

### Sound is too loud or small while using Android Auto.

- Adjust <Guidance/Voice Recognition Volume>, <Phone Incoming Volume>, <Phone Calling/Talking Volume> or <Media Volume> for <Android Auto> (page 12).

### Android Auto is deactivated.

- When you start Apple CarPlay, Android Auto is deactivated.

### USB Mirroring:

#### [USB Mirroring] is not highlighted on the source/option selection screen.

- Check whether [Mirroring for Android] is selected in the <Android Mode Select> (page 44).
- Check the version of the connected Android device—whether it is compatible with USB Mirroring.
- Check the Android device is connected properly for USB Mirroring. You can check the connection referring to the <Device List> screen.
- Check KENWOOD's Mirroring OA App is activated on Android device.

### USB Mirroring is deactivated.

- When you start Apple CarPlay, USB Mirroring is deactivated.

### No sounds from Android device come out of the speakers.

- Check the Android device is connected properly with Bluetooth.

## Troubleshooting

### USB

---

#### **“No File” appears.**

- The loaded USB does not contain any file of the selected type (audio/video/photo). Select the correct file type or replace the USB.

#### **“Reading” does not disappear from the screen.**

- Turn the power off and on again.

#### **While playing a file, sound is sometimes interrupted.**

- The tracks are not properly copied into the USB device. Copy the files again, and try again.

#### **Files are not played back as you have intended them to play.**

- Playback order may differ from the one played back using other players.

#### **The source does not change to [USB] when you connect a USB device while listening to another source or “USB Device Error” appears when you connect a USB device.**

- The USB port is drawing more power than the design limit.
- Turn the power off and unplug the USB device. Then, turn on the power and reattach the USB device.
- If the above does not solve the problem, turn the power off and on before replacing with another USB device.

### Digital Radio (DAB)

---

#### **Cannot receive an ensemble.**

- Your area is not covered by the ensemble.

#### **The DAB aerial is not properly extended or positioned.**

- Adjust the aerial and try the ensemble scanning again.
- Connect an active aerial (not supplied).

#### **“Antenna Error” appears.**

- The aerial has a short-circuit and the protective circuit has activated.
- Check the Digital Radio aerial. If a passive aerial without a booster is used, set aerial power to “OFF”.

### Radio

---

#### **AME automatic presetting does not work.**

- Store stations manually (page 26).

#### **Static noise while listening to the radio.**

- Connect the aerial firmly.

### AV-IN

---

#### **No picture appears on the screen.**

- While driving, no video is shown. You can only listen to the sounds.
- Select [AV-IN] for <AV Input> setting (page 42).
- Turn on the external component if it is not on.
- Connect the external component correctly.

### Cameras

---

#### **No picture appears on the screen.**

- Connect the camera correctly.

#### **Picture from the camera connected to the AV-IN terminal is not displayed on the screen.**

- Select [Camera] for <AV Input> setting (page 42).
- AV-IN camera does not function if an AVM is connected.

### Bluetooth hands-free phone

---

#### **Phone is disconnected.**

- When iPhone for Apple CarPlay or Android Auto device is connected, the currently connected Bluetooth device is disconnected. Use Apple CarPlay or Android Auto screen for phone.

#### **Phone sound quality is poor. Echo or noise occurs.**

- Reduce the distance between the unit and the Bluetooth mobile phone.
- Move the car to a place where you can get a better signal reception.
- Adjust the sound quality using <Microphone Level>, <Echo Cancel Level>, <Noise Reduction Level> (page 12).

#### **The unit does not respond when you try to copy the phone book to the unit.**

- You may have tried to copy the same entries (as stored) to the unit.

#### **“No Data” appears.**

- No phone book data is contained in the connected Bluetooth phone.

## Troubleshooting

### “Dial Error” appears.

→ Dialing has failed. Try the operation again.

### “Hung Up Error” appears.

→ The call has not ended yet. Park your car, and use the connected mobile phone to end the call.

### “Pick Up Error” appears.

→ The unit has failed to receive a call.

## Bluetooth audio

### Bluetooth audio played is disconnected.

→ When iPhone for Apple CarPlay or Android Auto device is connected, the currently connected Bluetooth device is disconnected.

### The sound is interrupted or skipped while using a Bluetooth audio player.

- Reduce the distance between the unit and the Bluetooth audio player. Disconnect the device connected for Bluetooth phone if any.
- Turn off, then turn on the unit.  
(When the sound is not yet restored) connect the player again.

### The connected audio player cannot be controlled.

→ Check whether the connected audio player supports AVRCP (Audio/Video Remote Control Profile).

## Specifications

### Monitor section

Picture Size (W × H)	6.75 inches (diagonal) wide 151.8 mm × 79.7 mm
Display System	TN LCD panel
Drive System	TFT active matrix system
Number of Pixels	1 152 000 (800H × 480V × RGB)
Effective Pixels	99.99%
Pixel Arrangement	RGB striped arrangement
Back Lighting	LED

### USB I/F section

Connector Type	Type-A
USB Standard	USB 2.0 Full Speed/High Speed
File System	FAT 16/32, exFAT
Maximum Power Supply Current	DC 5 V  1.5 A
D/A Converter	24 bits
Audio Decoder	MP3/WMA/AAC/WAV/FLAC
Video Decoder	MPEG1/MPEG2/MPEG4/ WMV/H.264/MKV

Frequency Response	192 kHz Sampling: 20 Hz to 20 000 Hz 96 kHz Sampling: 20 Hz to 20 000 Hz 48 kHz Sampling: 20 Hz to 20 000 Hz 44.1 kHz Sampling: 20 Hz to 20 000 Hz
Total Harmonic Distortion	0.010% (1 kHz)
Signal to Noise Ratio	98.5 dB
Dynamic Range	89 dB

### Bluetooth section

Technology	Bluetooth V5.0
Frequency	2.402 GHz to 2.480 GHz
RF Output Power (E.I.R.P.)	-8 dBm (MAX)
Maximum Communication Range	Line of sight approx. 10 m
Audio Codec	SBC/AAC
Multi Profile Support	Multi Profile

## Specifications

Profile	HFP (Hands Free Profile) V1.8 SPP (Serial Port Profile) A2DP (Advanced Audio Distribution Profile) V1.3.2 AVRCP (Audio/Video Remote Control Profile) V1.6.2 PBAP (PhoneBook Access Profile)
---------	---

### Digital radio (DAB) section

Frequency Range	BAND III: 174.928 MHz to 239.200 MHz
Sensitivity	100 dBm
Signal to Noise Ratio	90 dB
DAB Antenna Connector	Connector Type: SMB Output Voltage: (11 V to 16 V) DC12 V Maximum Current: < 100 mA

### Wi-Fi section

IEEE Standard	802.11 a/b/g/n/ac
Frequency Range	Dual Band (2.4 GHz/5 GHz)
Channels	Auto (1 – 11ch) Auto (149,153,155,157,161ch)
Transfer rates (MAX)	11a: 54 Mbps / 11b: 11 Mbps / 11g: 54 Mbps / 11n: 150 Mbps / 11ac: 433 Mbps
Output Power	2.4 GHz/SISO: 11b: +7 dBm (MAX) 11g: +7 dBm (MAX) 11n (20 MHz): +7 dBm (MAX) 5 GHz/SISO: 11a: +13 dBm (MAX) 11n (20 MHz): +13 dBm (MAX) 11n (40 MHz): +12 dBm (MAX) 11ac (40 MHz): +12 dBm (MAX) 11ac (80 MHz): +11 dBm (MAX) 5 GHz/MIMO: 11n (20 MHz): +13 dBm (MAX) 11n (40 MHz): +13 dBm (MAX) 11ac (40 MHz): +13 dBm (MAX) 11ac (80 MHz): +12 dBm (MAX)

### DSP section

Equalizer Band	13 Band Frequency (Hz): 62.5/100/160/250/400/630/ 1k/1.6k/2.5k/4k/6.3k/10k/ 16k Gain (dB): -9/-8/-7/-6/-5/-4/-3/-2/ -1/0/1/2/3/4/5/6/7/8/9
Tweeter:	Gain (dB): -8/-7/-6/-5/-4/-3/-2/-1/0
HPF:	Frequency (Hz): Through/30/40/50/60/70/ 80/90/100/120/150/180/ 220/250 Slope (dB/Oct): -6/-12/-18/-24 Gain (dB): -8/-7/-6/-5/-4/-3/-2/-1/0
LPF:	Frequency (Hz): 30/40/50/60/70/80/90/100/ 120/150/180/220/250/ Through Slope (dB/Oct): -6/-12/-18/-24 Gain (dB): -8/-7/-6/-5/-4/-3/-2/-1/0 Phase: Normal/Reverse

## Specifications

Tweeter HPF:	Frequency (Hz): 1k/1.6k/2.5k/4k/5k/6.3k/8k/ 10k/12.5k
	Slope (dB/Oct): -6/-12
	Gain (dB): -8/-7/-6/-5/-4/-3/-2/-1/0
	Phase: Normal/Reverse
Mid Range HPF:	Frequency (Hz): Through/30/40/50/60/70/ 80/90/100/120/150/180/ 220/250
	Slope (dB/Oct): -6/-12
	Gain (dB): -8/-7/-6/-5/-4/-3/-2/-1/0
	Phase: Normal/Reverse
Mid Range LPF:	Frequency (Hz): 1k/1.6k/2.5k/4k/5k/6.3k/8k/ 10k/12.5k/Through
	Slope (dB/Oct): -6/-12
	Gain (dB): -8/-7/-6/-5/-4/-3/-2/-1/0
	Phase: Normal/Reverse
Subwoofer LPF:	Frequency (Hz): 30/40/50/60/70/80/90/100/ 120/150/180/220/250/ Through
	Slope (dB/Oct): -6/-12
	Gain (dB): -8/-7/-6/-5/-4/-3/-2/-1/0
	Phase: Normal/Reverse

### FM radio section

Frequency Range (Frequency Step)	87.5 MHz to 108 MHz (50 kHz)
Usable Sensitivity (S/N: 30 dB)	6.2 dBf (0.56 $\mu$ V/75 $\Omega$ )
Quieting Sensitivity (DIN S/N: 46 dB)	15.2 dBf (1.58 $\mu$ V/75 $\Omega$ )
Frequency Response ( $\pm$ 3.0 dB)	30 Hz to 15 kHz
Signal to Noise Ratio	68 dB (MONO)
Selectivity ( $\pm$ 400 kHz)	> 80 dB
Stereo Separation	40 dB (1 kHz)

### LM radio section

Frequency Range (Frequency Step)	153 kHz to 279 kHz (9 kHz)
Usable Sensitivity	45 $\mu$ V

### MW radio section

Frequency Range (Frequency Step)	531 kHz to 1 611 kHz (9 kHz)
Usable Sensitivity	28.5 $\mu$ V

### Video section

Color System of External Video Input	NTSC/PAL
External Video Input Level (RCA jack)/(mini jack)	1 Vp-p/75 $\Omega$ 1 Vp-p/75 $\Omega$

External Audio Max Input Level (mini jack)	2 V/25 k $\Omega$
Video Input Level (RCA jack)	1 Vp-p/75 $\Omega$
Video Output Level (RCA jack)	1 Vp-p/75 $\Omega$

### Audio section

Maximum Power Output (Front & Rear)	50 W $\times$ 4
Typical Power Output (Front & Rear)	Full Bandwidth Power (at less than 1% THD) 22 W $\times$ 4
Output Frequency Band	20 Hz to 88 000 Hz
Preout Level	2.5 V/10 k $\Omega$
Preout Impedance	$\leq$ 600 $\Omega$
Speaker Impedance	4 $\Omega$ to 8 $\Omega$

### General

Operating Voltage	12 V DC car battery
Installation Dimensions (W $\times$ H $\times$ D)	Main unit: 180 mm $\times$ 100 mm $\times$ 75 mm With sleeve: 182 mm $\times$ 111 mm $\times$ 74 mm
Weight (Main Unit)	1.2 kg (including trim plate and sleeve)

Design and specifications are subject to change without notice.



# Trademarks and Licences

- Windows Media is a registered trademark or trademark of Microsoft Corporation in the United States and/or other countries. This product is protected by certain intellectual property rights of Microsoft. Use or distribution of such technology outside of this product is prohibited without a license from Microsoft.
- Use of the Made for Apple badge means that an accessory has been designed to connect specifically to the Apple product(s) identified in the badge and has been certified by the developer to meet Apple performance standards. Apple is not responsible for the operation of this device or its compliance with safety and regulatory standards. Please note that the use of this accessory with an Apple product may affect wireless performance.
- Apple, iPhone, and Lightning are trademarks of Apple Inc., registered in the U.S. and other countries.
- Apple, Siri, Apple CarPlay and Apple CarPlay logo are trademarks of Apple Inc., registered in the U.S. and other countries.
- App Store is a service mark of Apple Inc., registered in the U.S. and other countries.
- iOS is a trademark or registered trademark of Cisco in the U.S. and other countries and is used under license.
- Google, Android, Android Auto, Google Maps and other marks are trademarks of Google LLC.
- To use Android Auto on your car display, you'll need an Android Auto compatible vehicle or aftermarket stereo, an Android phone running Android 6.0 or higher, an active data plan, and the Android Auto app.
- Wi-Fi® is a registered trademark of Wi-Fi Alliance®.
- The Wi-Fi CERTIFIED™ Logo is a registered trademark of Wi-Fi Alliance®.
- The Bluetooth® word mark and logos are registered trademarks owned by Bluetooth SIG, Inc. and any use of such marks by JVCKENWOOD Corporation is under license. Other trademarks and trade names are those of their respective owners.
- Font for this product is RT Font designed and sold by Ricoh Industrial Solutions Inc.
- Linux® is the registered trademark of Linus Torvalds in the U.S. and other countries.
- THIS PRODUCT IS LICENSED UNDER THE AVC PATENT PORTFOLIO LICENSE FOR THE PERSONAL USE OF A CONSUMER OR OTHER USES IN WHICH IT DOES NOT RECEIVE REMUNERATION TO  
(i) ENCODE VIDEO IN COMPLIANCE WITH THE AVC STANDARD ("AVC VIDEO") AND/OR (ii) DECODE AVC VIDEO THAT WAS ENCODED BY A CONSUMER ENGAGED IN A PERSONAL ACTIVITY AND/OR WAS OBTAINED FROM A VIDEO PROVIDER LICENSED TO PROVIDE AVC VIDEO. NO LICENSE IS GRANTED OR SHALL BE IMPLIED FOR ANY OTHER USE. ADDITIONAL INFORMATION MAY BE OBTAINED FROM MPEG LA, L.L.C. SEE [HTTP://WWW.MPEGLA.COM](http://www.MPEGLA.COM)
- THIS PRODUCT IS LICENSED UNDER THE MPEG-4 VISUAL PATENT PORTFOLIO LICENSE FOR THE PERSONAL AND NON-COMMERCIAL USE OF A CONSUMER FOR  
(i) ENCODING VIDEO IN COMPLIANCE WITH THE MPEG-4 VISUAL STANDARD ("MPEG-4 VIDEO") AND/OR (ii) DECODING MPEG-4 VIDEO THAT WAS ENCODED BY A CONSUMER ENGAGED IN A PERSONAL AND NON-COMMERCIAL ACTIVITY AND/OR WAS OBTAINED FROM A VIDEO PROVIDER LICENSED BY MPEG LA TO PROVIDE MPEG-4 VIDEO. NO LICENSE IS GRANTED OR SHALL BE IMPLIED FOR ANY OTHER USE. ADDITIONAL INFORMATION INCLUDING THAT RELATING TO PROMOTIONAL, INTERNAL AND COMMERCIAL USES AND LICENSING MAY BE OBTAINED FROM MPEG LA, LLC. SEE [HTTP://WWW.MPEGLA.COM](http://www.MPEGLA.COM)
- THIS PRODUCT IS LICENSED UNDER THE VC-1 PATENT PORTFOLIO LICENSE FOR THE PERSONAL AND NON-COMMERCIAL USE OF A CONSUMER TO  
( i ) ENCODE VIDEO IN COMPLIANCE WITH THE VC-1 STANDARD ("VC-1 VIDEO") AND/OR ( ii ) DECODE VC-1 VIDEO THAT WAS ENCODED BY A CONSUMER ENGAGED IN A PERSONAL AND NON-COMMERCIAL ACTIVITY AND/OR WAS OBTAINED FROM A VIDEO PROVIDER LICENSED TO PROVIDE VC-1 VIDEO. NO LICENSE IS GRANTED OR SHALL BE IMPLIED FOR ANY OTHER USE. ADDITIONAL INFORMATION MAY BE OBTAINED FROM MPEG LA, L.L.C. SEE [HTTP://WWW.MPEGLA.COM](http://www.MPEGLA.COM)

### Important Notice on Software

#### Software License on This Product

The software embedded in this product comprises a number of independent software components, each of which is copyrighted by JVCKENWOOD Corporation or by a third party.

This product uses software components that are based on an End-User License Agreement (hereinafter called "EULA") stipulated by JVCKENWOOD Corporation and by third parties.

The EULA dictates the availability of the source codes of free-software components as a prerequisite to distributing them in executable form under the terms of the GNU General Public License or the Lesser General Public License (hereinafter called "GPL/LGPL"). To get information about the software components that are subject to the terms of the GPL/LGPL, please visit the following Website:

Website URL <https://www2.jvckenwood.com/gpl/>

Queries concerning the contents of the source code or the like will not be accepted.

Please note that software components based on a EULA that is not subject to the terms of the GPL/LGPL or those that have been developed or created by JVCKENWOOD Corporation will be excluded from the scope of source code disclosure.

Because licenses to use software components distributed under the GPL/LGPL are offered to the customers for free of charge, no warranty is granted to the customers, whether explicitly or implicitly, to the extent of the applicable laws.

Unless otherwise stipulated by the applicable laws or agreed upon in writing, the copyright holders or those who are entitled to modify and redistribute the software components are not held responsible for any and all damages resulting from their use or from inability to use them. For more information about the terms of use of the software components, required items of compliance and so on, please refer to the GPL/LGPL.

Customers wishing themselves to use a software component that is subject to the GPL/LGPL embedded in this product are encouraged to read the terms of the corresponding license before use. Because each individual license is prescribed by a third party other than JVCKENWOOD Corporation, the original (English) of the license is presented.

### EULA

#### Software License Agreement

JVCKENWOOD Corporation (hereinafter called "Licensor") holds either the copyright to the embedded software or the right to sublicense it. This agreement establishes the conditions under which the customer uses this "Licensed Software."

The customer shall agree to the terms of this license agreement before proceeding to use Licensed Software.

This agreement is deemed to have taken effect when the customer (hereinafter called "User") has used a product implementation of Licensed Software.

The Licensed Software may contain software Licensor has been licensed to use by third parties directly or indirectly. Some third parties may have terms of use prescribed for their customers, apart from this Software License Agreement. This agreement does not apply to such software. Be sure to consult "Important Notice on Software" as presented separately.

#### Article 1 (General)

Licensor grants to User a non-exclusive, non-assignable right of use Licensed Software within the country where the User purchases the Product (hereinafter the "Country") (except for the exception provided for in Paragraph 1, Article 3).

#### Article 2 (Right of Use)

1. The rise of use granted under this agreement is the right to use Licensed Software in this product.
2. User may not duplicate, copy, modify, add to, translate or otherwise alter, or loan licensed Software and the associated literature in whole or in part.
3. Use of Licensed Software is limited to a private extent, and Licensed Software may not be distributed, licensed or sublicensed for any purposes whatsoever, including commercial use.
4. User shall use Licensed Software as per the instruction manual or instructions given in the help file and may not use or duplicate data in violations of the regulations of the Copyright Law or other governing laws by using Licensed Software in whole or in part.

## Trademarks and Licences

### Article 3 (Terms of License)

1. In assigning this product, User may not retain the original copy of the embedded Licensed Software (including associated literature, updates and upgrades) and any duplicates and associated literature with regard to the license to use Licensed Software. User may transfer Licensed Software only to the condition of binding the assignee to abide by the terms of this Software License Agreement.
2. User may not reverse-engineer, disassemble, decompile or otherwise analyze the source code of Licensed Software.

### Article 4 (Rights to Licensed Software)

All rights to Licensed Software and the associated literature, including copyrights, shall reside with Licensor or the original right holder who has granted the Right of Use and right to sublicense to Licensor (hereinafter referred to as "Original Right Holder"), and User does not have any rights other than Right of Use granted hereunder with regard to Licensed Software and the associated literature.

### Article 5 (Exemption Granted to Licensor)

1. Licensor and Original Right Holder do not assume any responsibility for damages caused to User or third parties resulting from the exercise by User of the license granted hereunder, unless otherwise provided by any law to the contrary.
2. Licensor does not warrant Licensed Software to be merchantable, compatible and fit for specific purposes.

### Article 6 (Responsibility for Third Parties)

If disputes over the infringement of third parties' intellectual property rights, such as copyrights and patent rights, arise out of the use of Licensed Software by User, User shall resolve these disputes at User's own expenses while keep Licensor and Original Right Holder harmless.

### Article 7 (Secrecy Obligation)

User shall keep confidential Licensed Software provided hereunder, information contained in the associated literature or the like and those provisions of this agreement not yet in public knowledge and may not disclose or leak these to third parties without prior written consent from Licensor.

### Article 8 (Cancellation of the Agreement)

Licensor reserves the right to cancel this agreement forthwith and claim compensation from User for the damages caused by such cancellation when User:  
(1) Breaches any of the provisions of this agreement, or  
(2) Has received a petition for seizure, provisional seizure, provisional disposition or any other kind of compulsory execution.

### Article 9 (Destruction of Licensed Software)

If this agreement is terminated under the provision of the foregoing paragraph, User shall destroy Licensed Software, along with all associated literature and its duplicates, within two (2) weeks from the date of termination.

### Article 10 (Copyright Protection)

1. Copyrights and all other intellectual property rights relating to Licensed Software shall reside with Licensor and Original Right Holder and in no circumstances with User.
2. User shall abide by the laws relating to copyrights and intellectual property rights in using Licensed Software.

### Article 11 (Export Control)

1. Licensed Software and the associated literature or the like may not be exported to places outside the Country (including transmission outside the Country over the Internet or the like).
2. User agrees that Licensed Software is subject to export controls imposed by the Country and the United States of America.
3. User agrees to comply with all the international and domestic laws that apply to this software (U.S. Export Administration Regulations and regulations established by the U.S., the Country and their governmental agencies regarding usage by end users and export destinations).

### Article 12 (Miscellaneous)

1. Even if this agreement is invalidated in part by law, all other provisions shall remain in effect.
2. Licensor and User shall consult each other in good faith to resolve any matters not provided for in this agreement or questions arising from the interpretation of this agreement.
3. Licensor and User agree that this agreement is governed by the law of Japan and that all dispute involving claims and obligations that may arise out of this agreement will be settled by arbitration at the Tokyo District Court as the court of first instance.

For updated information (the latest Instruction Manual, system updates, new functions, etc.),  
please visit the following website:

[<https://www.kenwood.com/cs/ce/>](https://www.kenwood.com/cs/ce/)



android  
auto