

Instruction Manual

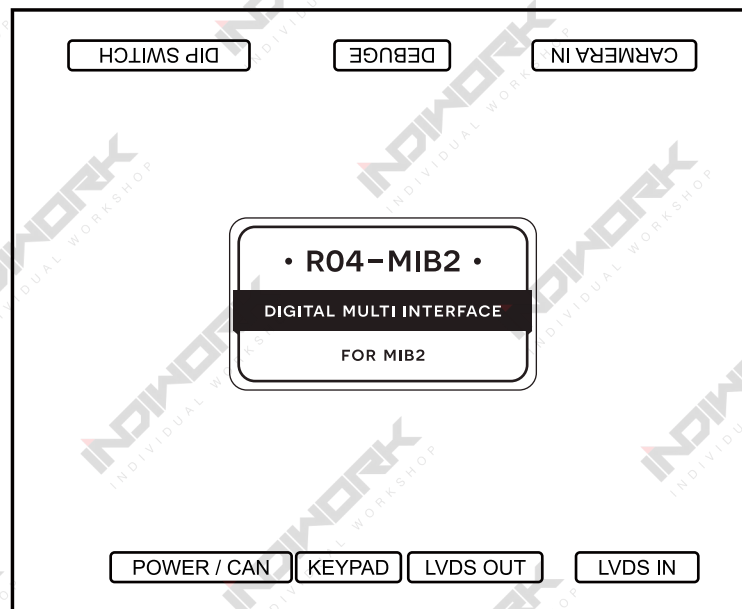













REAR INTERFACE for MIB2

R04-MIB2



Model Name	R04-MIB2
Latest Firmware Date	2020 - 02 - 28
Manual Version	Rev. 1.5
Language	English

Contents

- **Precautions** _____ 
- **Car Compatibility Chart **AUDI**** _____ 
- **Car Compatibility Chart **VW, Skoda**** _____ 
- **Car Compatibility Chart **Porsche, Bentley**** _____ 
- **Dimension & Exterior** _____ 
- **Components & Optional Parts** _____ 
- **Body Connector specifications** _____ 
- **Full Installation Diagram DIP Switch Settings** _____ 
- **Activation by original buttons **AUDI VW, Skoda**** _____ 
- **Activation by original buttons **Porsche, Bentley**** _____ 
- **Settings **(How To Use KEYPAD)**** _____ 
- **Settings REAR VIEW** _____ 
- **Settings REAR VIEW** _____ 
- **Settings AV1 (FRONT VIEW) **(OEM Camera delay time setting)**** _____ 

Precautions

- **IW-MIB2-N23 - related**

You should check the names and colors of each wires exactly, before you connect the wires.

ex) CAN HIGH: White wires / CAN LOW: Blue wires

The 'POWER / CAN Cable' should always be connected last and be disconnected first.

The 'Keypad' is an optional part to change modes forcibly without CAN-BUS.

When the reverse gear is not detected by CAN-BUS,
the 'REVERSE 12V IN wire' should be spliced with 1 2V power of reverse light.

Please. Never input 12V power to the cable's REAR 12V OUT '

Car Compatibility Chart



Car Models	Production Year	Specific Modelsv
A3	2013 - 2016	- Audi A3 MMI Radio - Audi A3 MMI Navigation Plus
A4	2016 -	- MIB2 STD, MIB2 Main-Unit
A6	2016 -	- 4G MMI
A7	2016 -	- 4G MMI
Q5	2016 -	- MIB2 STD, MIB2 Main-Unit
Q7	2016 -	- MIB2 STD, MIB2 Main-Unit



AUDI A3(7inch)



AUDI A3 (5.8inch)



AUDI A4 ,Q5



AUDI Q7

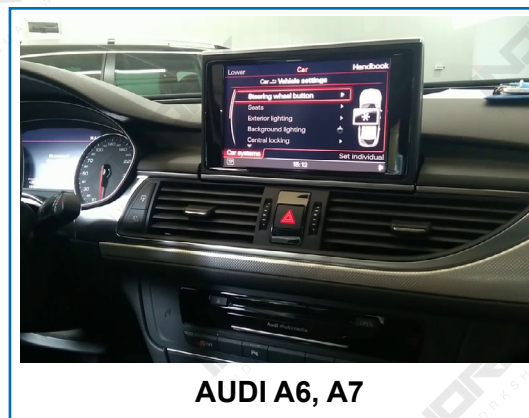

AUDI A6, A7

 Click
Go to DIP Swtich Setting page

 Click
Go to contents page

Car Compatibility Chart



Car Models	Production Year	Specific Models
POLO	2016 -	- VW Composition Media (6.5inch, 8-inch) - VW Discover Media Pro (6.5inch, 8-inch) - 2017 Discover Media, Pro(8inch, 9.2-inch)
GOLF	2016 -	- VW Composition Media (6.5inch, 8-inch) - VW Discover Media Pro (6.5inch, 8-inch) - 2017 Discover Media, Pro(8inch, 9.2-inch)
TIGUAN	2016 -	- 2017 Discover Media, Pro(8inch, 9.2-inch)
PASSAT	2016 -	- 2017 Discover Media, Pro(8inch, 9.2-inch)



**Composition Media
(5.8inch, 6.5inch, 8inch)**



**Discover Pro(8-inch)
Discover Media (6.5inch, 8inch)**



2017 Discover Media (8-inch)



2017 Discover Pro(9.2-inch)



Car Models	Production Year	Specific Models
Octavia	2016 -	- 2017 Discover Media, Pro(8inch, 9.2-inch)

Car Compatibility Chart



PORSCHE

Car Models	Production Year	Specific Models
911 Carrera (991)	2017 -	- PCM 4.0
Macan	2017 -	- PCM 4.0



MACAN PCM 4.0



BENTLEY

Car Models	Production Year	Specific Models
BENTAYGA	2016 -	- Bentley Infotainment



Bentley Infotainment



Click
Go to DIP Swtich Setting page



Click
Go to contents page

Dimension

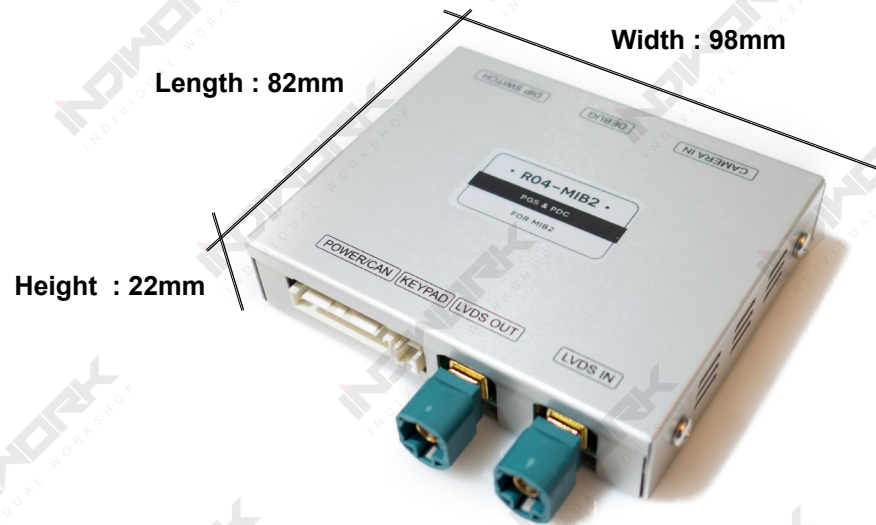

Exterior

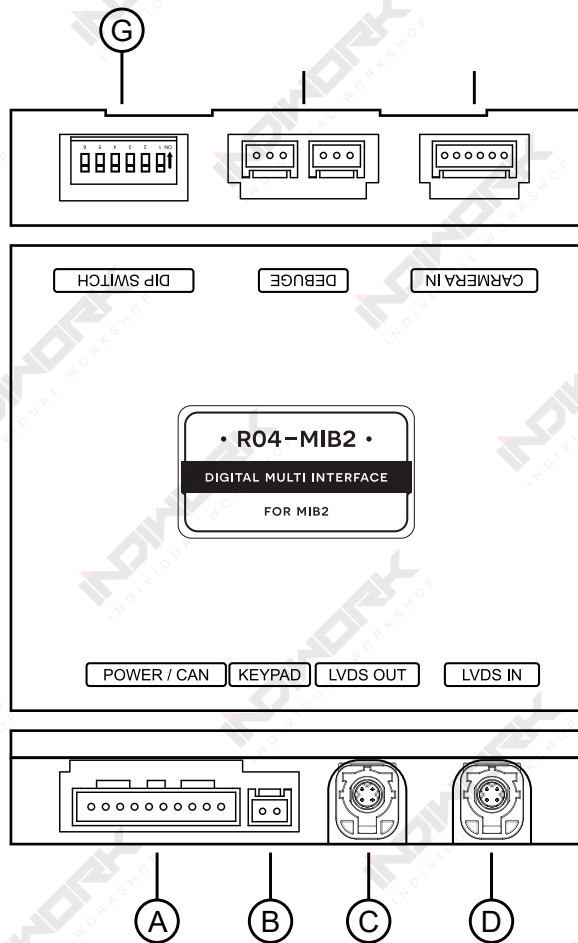

- (A) POWER / CAN
- (B) KEYPAD
- (C) LVDS OUT
- (D) LVDS IN
- (E) CAMERA IN
- (F) DEBUGE
- (G) DIP SWITCH

Components



1.Power Cable



2.LVDS Cable



3.LVDS Cable

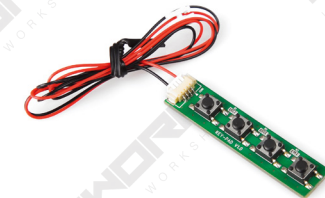

4.LVDS Cable

Optional Parts (sold separately at the indiwork)



Extend LVDS Cable

Body Connector specifications

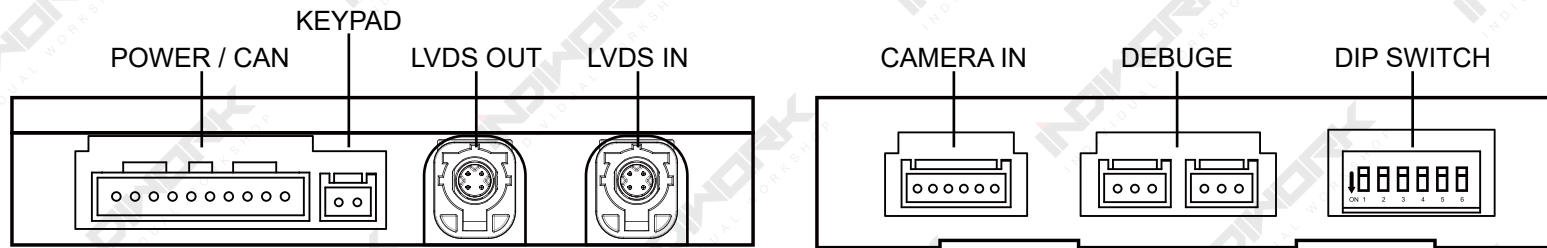

POWER/CAN CABLE

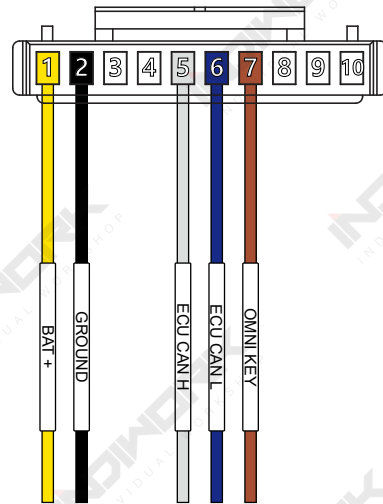

POWER / CAN CABLE	
1	BATTERY POWER INPUT
2	GROUND
3	
4	
5	ECU_CAN_H
6	ECU_CAN_L
7	OMNI KEY
8	
9	
10	

LVDS CABLE



AV CABLE

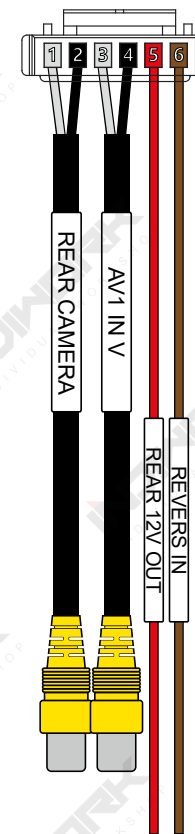

AV CABLE	
1	RV-CAM VIDEO INPUT
2	GND(RV-CAM VIDEO)
3	AV1 VIDEO INPUT
4	GND(AV1 VIDEO IN)
5	RV-CAM POWER OUT
6	REVERSE DETECTION

Full Installation Diagram

Click
Go to contents page

DIP Switch Settings



PIN	ON (▼)	OFF (▲)
1	External Rear View Camera	Original Rear View Mode (OEM CAMERA)
2	External Front View Camera(AV1 Mode)	Skip External Front View Camera(AV1 Mode)
3	Selection of car model	
4		
5		
6		

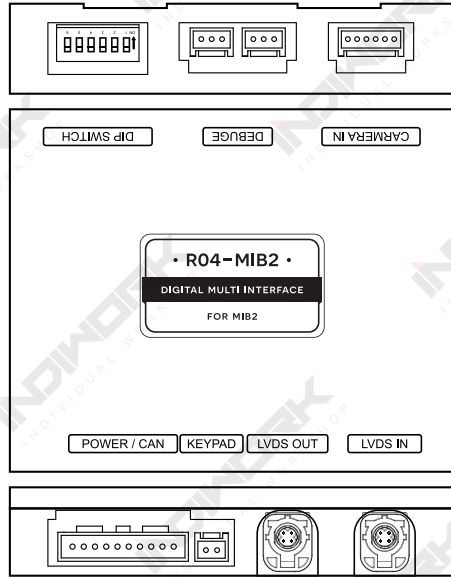

	No.3	No.4	No.5	No.6	Car Model	Remarks
Volkswagen	OFF(▲)	OFF(▲)	OFF(▲)	OFF(▲)	VW / GOLF,PASSAT,TIGUAN SKODA / Octavia	2017 Discover Media / 8-inch Discover Media, Pro / 6.5, 8-inch Composition Media / 6.5, 8-inch
	OFF(▲)	ON(▼)	OFF(▲)	OFF(▲)	VW / GOLF,PASSAT,TIGUAN SKODA / Octavia	2017 Discover Pro / 9.2-inch
	OFF(▲)	ON(▼)	ON(▼)	OFF(▲)	VW / GOLF,PASSAT,TIGUAN SKODA / Octavia	Composition Media / 5.8 inch Composition Colour / 5.8 inch
SKODA	ON(▼)	OFF(▲)	OFF(▲)	OFF(▲)	VW / GOLF,PASSAT,TIGUAN SKODA / Octavia	2017 Discover Media / 8-inch Discover Media, Pro / 6.5, 8-inch Composition Media / 6.5, 8-inch
	ON(▼)	ON(▼)	ON(▼)	OFF(▲)	VW / GOLF,PASSAT,TIGUAN SKODA / Octavia	Composition Media / 5.8 inch Composition Colour / 5.8 inch
Audi	OFF(▲)	OFF(▲)	ON(▼)	OFF(▲)	2017~ Audi Q7 2017~ Audi Q5	MIB2 / 8.3 inch
	OFF(▲)	ON(▼)	ON(▼)	ON(▼)	2017~ Audi A4 2017~ Audi Q5	MIB2 / 7 inch
	ON(▼)	OFF(▲)	OFF(▲)	ON(▼)	2013~2016 Audi A3	Audi A3 MMI Radio / 7 inch
	ON(▼)	OFF(▲)	ON(▼)	OFF(▲)	2013~2016 Audi A3	Audi A3 MMI Radio / 5.8 inch (Low Resolution)
	ON(▼)	OFF(▲)	ON(▼)	ON(▼)	2016~ Audi A6(C7), A7(4G8) *facelift	MIB2 / 8 inch
	OFF(▲)	ON(▼)	OFF(▲)	ON(▼)	Porsche Macan	PCM4.0 / 8 inch
Bentley	OFF(▲)	OFF(▲)	OFF(▲)	ON(▼)	Bentley BENTAYGA	MIB2 / 8 inch

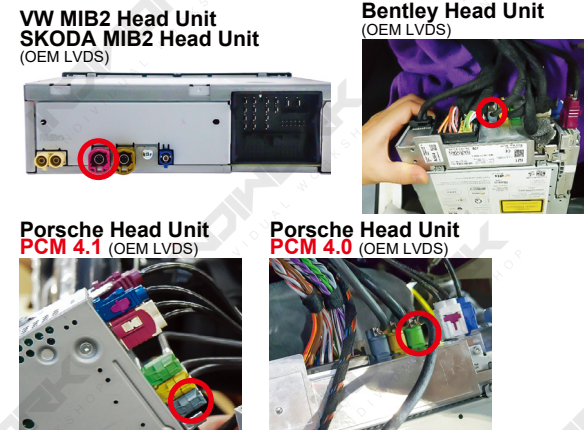
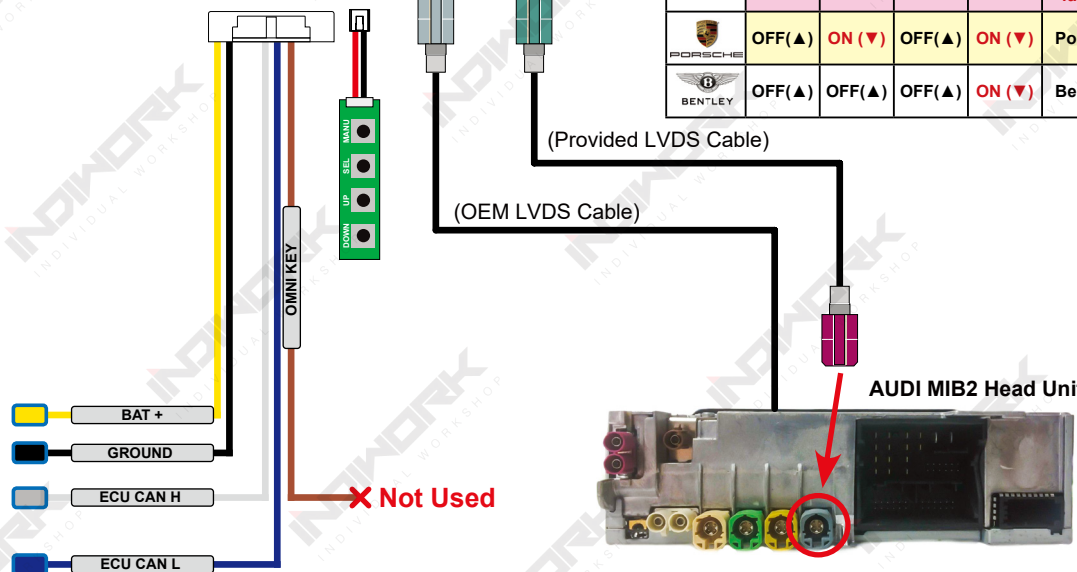
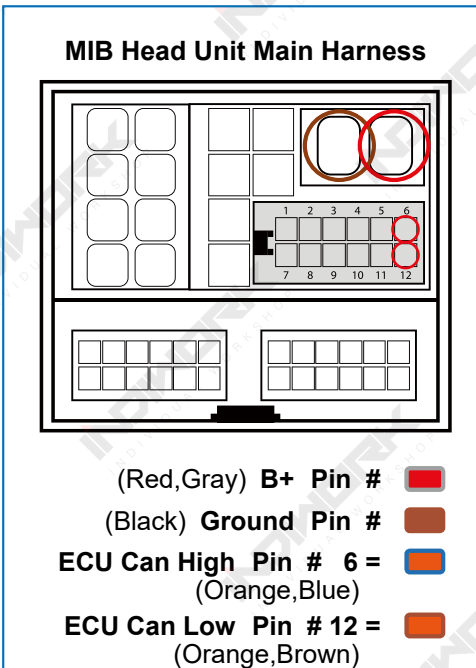

Activation by original buttons

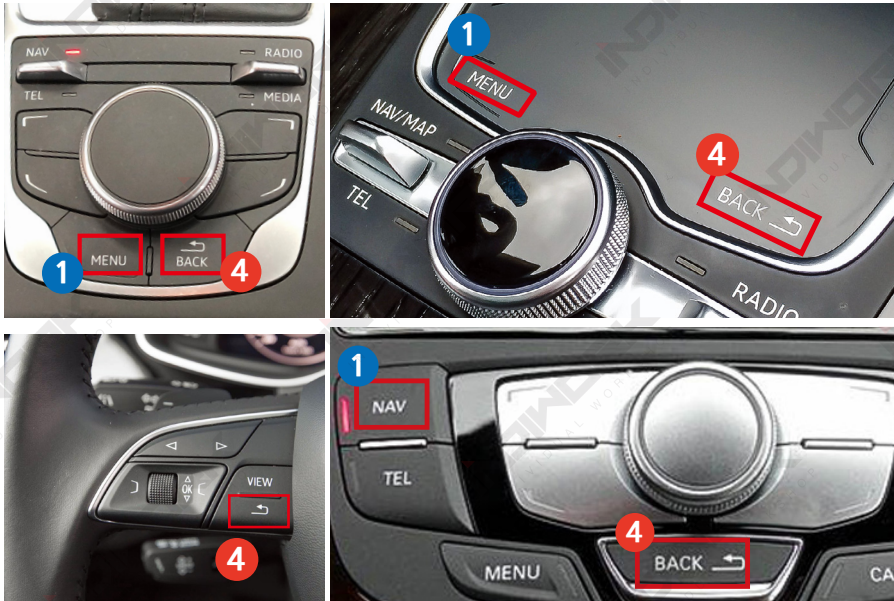

Button	Function	Operation	Remarks
4 BACK	Changing Modes (Front Cam)	Press the button 2 seconds	Order : AV1 (Front View Camera)
		Press the button short time	Order : AV1 → Previous screen
1 MENU	Reset	Press the button 10 seconds	You can use this function when you get in trouble

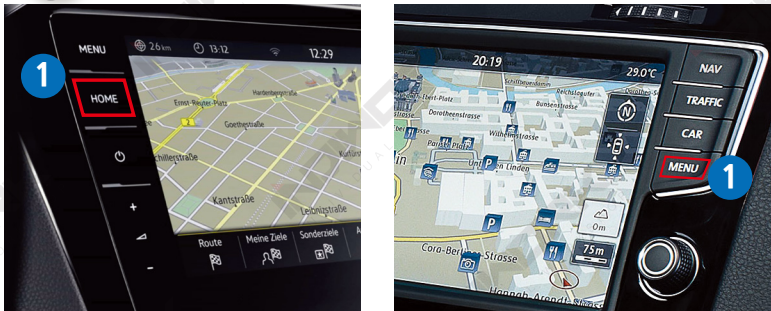

2017 Discover Pro(9.2-inch) Volkswagen Discover Pro(8-inch)



Steering Wheel Buttons



PDC Button

Button	Function	Operation	Remarks
2 ▽	Changing Modes (Front Cam)	Press the button 2 seconds	Order : AV1 (Front View Camera)
		Press the button short time	Order : AV1 → Previous screen
3 PDC BUTTON	Changing Modes	Press the button short time	Order : → OEM
1 MENU	Reset	Press the button 10 seconds	You can use this function when you get in trouble

Activation by original buttons



PORSCHE



Porsche PCM 4.0

Button	Function	Operation	Remarks
1 NAV	Changing Modes	Press the button 2 seconds	Order : AV1 → OEM
		Press the button short time	Return to the OEM mode in any modes.
1 NAV	Reset	Press the button 10 seconds	You can use this function when you get in trouble



BENTLEY



Button	Function	Operation	Remarks
1 HOME	Changing Modes	Press the button 2 seconds	Order : AV1 → OEM
		Press the button short time	Return to the OEM mode in any modes.
1 HOME	Reset	Press the button 10 seconds	You can use this function when you get in trouble

Settings (How To Use KEYPAD)

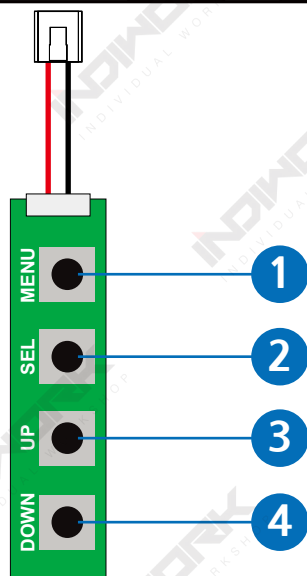
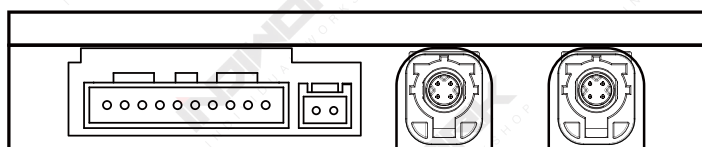
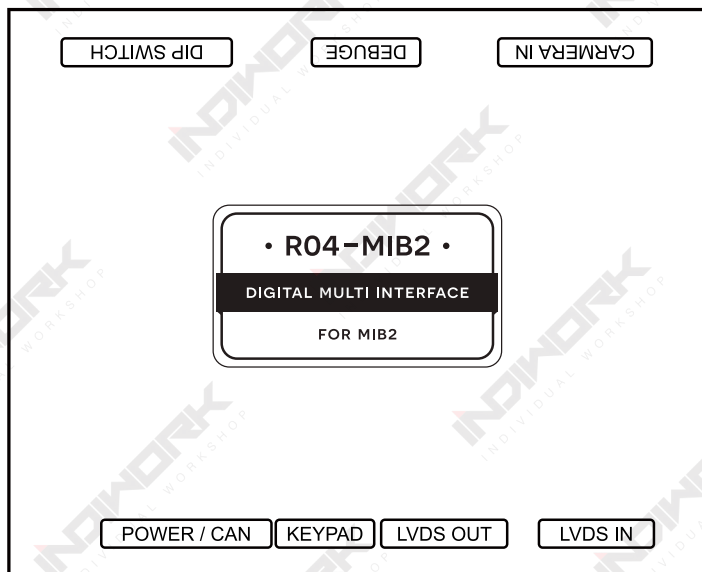

KEYPAD - Function #1

Button	Function	Operation	Remarks
1 MENU	Changing Modes	Press the button short time	Order : AV1 → OEM
2 SEL	Enter into the setting menu	Press the button short time	

KEYPAD - Function #2

Button	Function	Operation
1 MENU	Back to previous menu When press the button short.	Press the button short time
2 SEL	Select the setting menu and setting values.	Press the button short time
3 UP 4 DOWN	Move the menu-pointer and adjust the setting values	Press the button short time

Settings

R04-MIB2		
HDMI 1	INPUT SOURCE	OEM CAMERA
HDMI 2	BRIGHT	AVM (AROUND VIEW)
HDMI 3	CONTRAST RED	EXTERNAL CAMERA
NAVIGATION	CONTRAST GREEN	
REAR VIEW	CONTRAST BLUE	
AV1 (FRONT VIEW)		
AV2 (DTV)		
AV3 (DVD)		
CUSTOM		
EXIT		
DIP SWITCH INFO :		FIRMWARE DATE :
		MAIN : 2018-03-02
		SUB : 2018-03-02
		TW23 : 2018-03-02

R04-MIB2		
HDMI 1	INPUT SOURCE	DEFAULT
HDMI 2	BRIGHT	128
HDMI 3	CONTRAST RED	128
NAVIGATION	CONTRAST GREEN	128
REAR VIEW	CONTRAST BLUE	128
AV1 (FRONT VIEW)	AVM KEEPING TIME R → D	7 Sec
AV2 (DTV)	AVM KEEPING TIME P → D	7 Sec
AV3 (DVD)	PGS ON / OFF	OFF
CUSTOM	PGS - HORIZONTAL	128
EXIT	PGS - VERTICAL	128
	PDC ON / OFF	OFF
DIP SWITCH INFO :		FIRMWARE DATE :
		MAIN : 2018-03-02
		SUB : 2018-03-02
		TW23 : 2018-03-02

REAR VIEW INPUT - OEM CAMERA

- INPUT SOURCE

- OEM CAMERA
- AVM (360° Around View Camera)
- EXTERNAL CAMERA

- BRIGHT and CONTRAST

Adjust the values of brightness and contrast

REAR VIEW INPUT - AVM

- BRIGHT and CONTRAST

Adjust the values of brightness and contrast

- AVM KEEPING TIME



If the keeping time set is "OFF"

The AVM screen stayed

When the "P" button while active and

When the "P" button will be disabled.

The Screen will be change to previous screen

- When you shift gear 'from reverse to drive' or 'from parking to drive', it just works automatically during the activation time you selected.

- PGS (Parking Guide System)

- Adjust position of parking guide lines and select the lines 'ON or OFF'.

Settings

R04-MIB2		
HDMI 1	INPUT SOURCE	EXTERNAL CAMERA
HDMI 2	BRIGHT	128
HDMI 3	CONTRAST RED	128
NAVIGATION	CONTRAST GREEN	128
REAR VIEW	CONTRAST BLUE	128
AV1 (FRONT VIEW)	PGS ON / OFF	OFF
AV2 (DTV)	PGS - HORIZONTAL	128
AV3 (DVD)	PGS - VERTICAL	128
CUSTOM	PDC ON / OFF	OFF
EXIT		
DIP SWITCH INFO :		FIRMWARE DATE :
		MAIN : 2018-03-02 SUB : 2018-03-02 TW23 : 2018-03-02

REAR VIEW INPUT - EXTERNAL CAMERA

- BRIGHT and CONTRAST

Adjust the values of brightness and contrast

- PGS (Parking Guide System)

Adjust position of parking guide lines and select the lines 'ON or OFF'.

Settings

R04-MIB2		
HDMI 1	INPUT SOURCE	OEM CAMERA
HDMI 2	CAM KEEPING TIME R → D	7 Sec
HDMI 3	CAM KEEPING TIME P → D	7 Sec
NAVIGATION		
REAR VIEW		
AV1 (FRONT VIEW)		
AV2 (DTV)		
AV3 (DVD)		
CUSTOM		
EXIT		
DIP SWITCH INFO :		FIRMWARE DATE :
		MAIN : 2018-03-02 SUB : 2018-03-02 TW23 : 2018-03-02

AV1 (FRONT VIEW INPUT) - OEM CAMERA

- CAM KEEPING TIME

- When you shift gear 'from reverse to drive' or 'from parking to drive', it just works automatically during the activation time you selected.

R04-MIB2		
HDMI 1	INPUT SOURCE	EXTERNAL CAMERA
HDMI 2	BRIGHT	128
HDMI 3	CONTRAST RED	128
NAVIGATION		
REAR VIEW		
AV1 (FRONT VIEW)		
AV2 (DTV)		
AV3 (DVD)		
CUSTOM		
EXIT		
DIP SWITCH INFO :		FIRMWARE DATE :
		MAIN : 2018-03-02 SUB : 2018-03-02 TW23 : 2018-03-02

AV1 (FRONT VIEW INPUT) - EXTERNAL CAMERA

- BRIGHT and CONTRAST

Adjust the values of brightness and contrast

- FRONT CAM KEEPING TIME

- When you shift gear 'from reverse to drive' or 'from parking to drive', it just works automatically during the activation time you selected.

Manufactured by
MICROCITY

Distributed by
INDIWORK
INDIVIDUAL WORKSHOP

[www.**INDIWORK**.co.kr](http://www.indiwork.co.kr)

Copyright © indiwork. All Rights Reserved.