

# INSTRUCTION MANUAL

---

**27-870**

CARPLAY/ANDROID AUTO INTEGRATION FOR  
PEUGEOT NAC SYSTEM

---

# CONTENT

Compatibility.....	4
Features .....	5
Package Components .....	6
Connection Diagram .....	7
DIP Setting .....	8
Operation Instruction .....	9
How To Switch From Original To Add On Interface .....	9
How To Delivering Audio To OEM Radio.....	9
Add On Module UI.....	10
Apple CarPlay .....	11
Android Auto.....	12
Screen Mirroring .....	13

---

## WARNING

In order to protect the driving safety and avoid break the traffic law; please DO NOT operate the interface while driving.

The reversing surveillance function just is used in reversing assistance. Please check the entire surroundings while reversing.

All steps of installation should be done by the well-trained specialist.

During installation, the ignition key should be taken off and after all installation finished, connect power cable last.

Please DO NOT plug or pull the connected cables in the state of power-on, in order to avoid damaged monitor or accessory.

Install wiring in a manner in which cables will not come in contact with metal parts. The wiring may be damaged by contact with metal parts, resulting in fire and shocks. Avoid all contact with hot surfaces when wiring the main unit. High temperatures may damage wiring, causing shorts, arcing and fires.

Please DO NOT put the product in the damp environment or water, in order to avoid electric shock, damaged and fire accident caused by a short circuit.

Kindly check all components are in the box when receiving the product. If anything missing, inform to the supplier/manufacturer.

Start the engine before loading, check the interface whether have function displayed, key control whether correct, the vehicle interface whether having a scratch. Please give the feedback to the supplier/manufacturer if there have any questions.

Please note that put the disassembled automotive components in a good way on the installation process, avoid scratching the instrument panel, the leftovers of connecting cables need to handle and DO NOT leave it in the car. The connecting plug must be insulated in order to short circuit.

The cables should be connected in a good way, the vehicle installation space is a little small, so reduce space usage as far as possible. There should be a good plan about connect cables, avoid affecting the active component of connecting, such as control components of turning the steering wheel, throttle and brake pedal. There need to be fastened after connecting cables in case of a drop.

## COMPATIBILITY

Make	Models	Years	Original system
Peugeot	208, 308, 2008, 3008, 4008, 5008	2016-	NAC system
Citroën	C3, C4, C6		
Toyota	ProAce		
Vauxhall	Crossland		Navi 5.0 IntelliLink



---

## FEATURES

Integrated 3 in 1 module supports Apple CarPlay, Android Auto, and screen mirroring functions

Support USB HD video and lossless music playback (APE, WAV, FLAC, MP3, WMA, etc.)

Offers 2 video in for front/rear view camera and 1 AV in for external AV device like digital TV tuner

Support PDC (Parking Distance Control) and FPG (Flexible Parking Guidelines)

Supply pure 12V power to the front/rear view camera

Display front view automatically after shifting from “R” gear

VGA input for specific 360 panoramic system, offers a clearer picture

Operate by stock touch screen and steering wheel buttons

Support OEM microphone

Support further software update



CarPlay



Android  
Auto



Mirroring



USB  
Multimedia



FPG



PDC



F/R View  
Camera



Software  
Update

---

# PACKAGE COMPONENTS



Main Unit

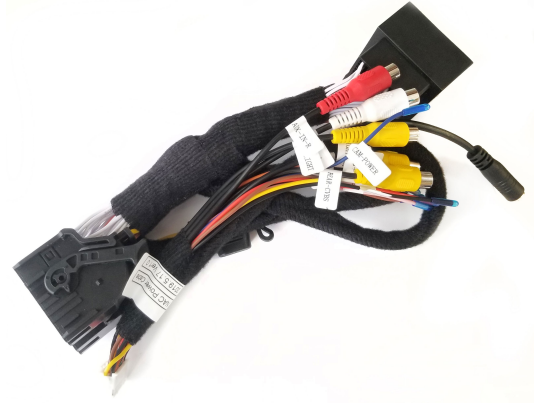

Quadlock Power Cable



LVDS Cable



USB/MIC Cable



AUX-USB Adapter



3.5mm AUX Cable

## Optional Components:

External  
Microphone  
(Designed for  
car without  
factory  
microphone)



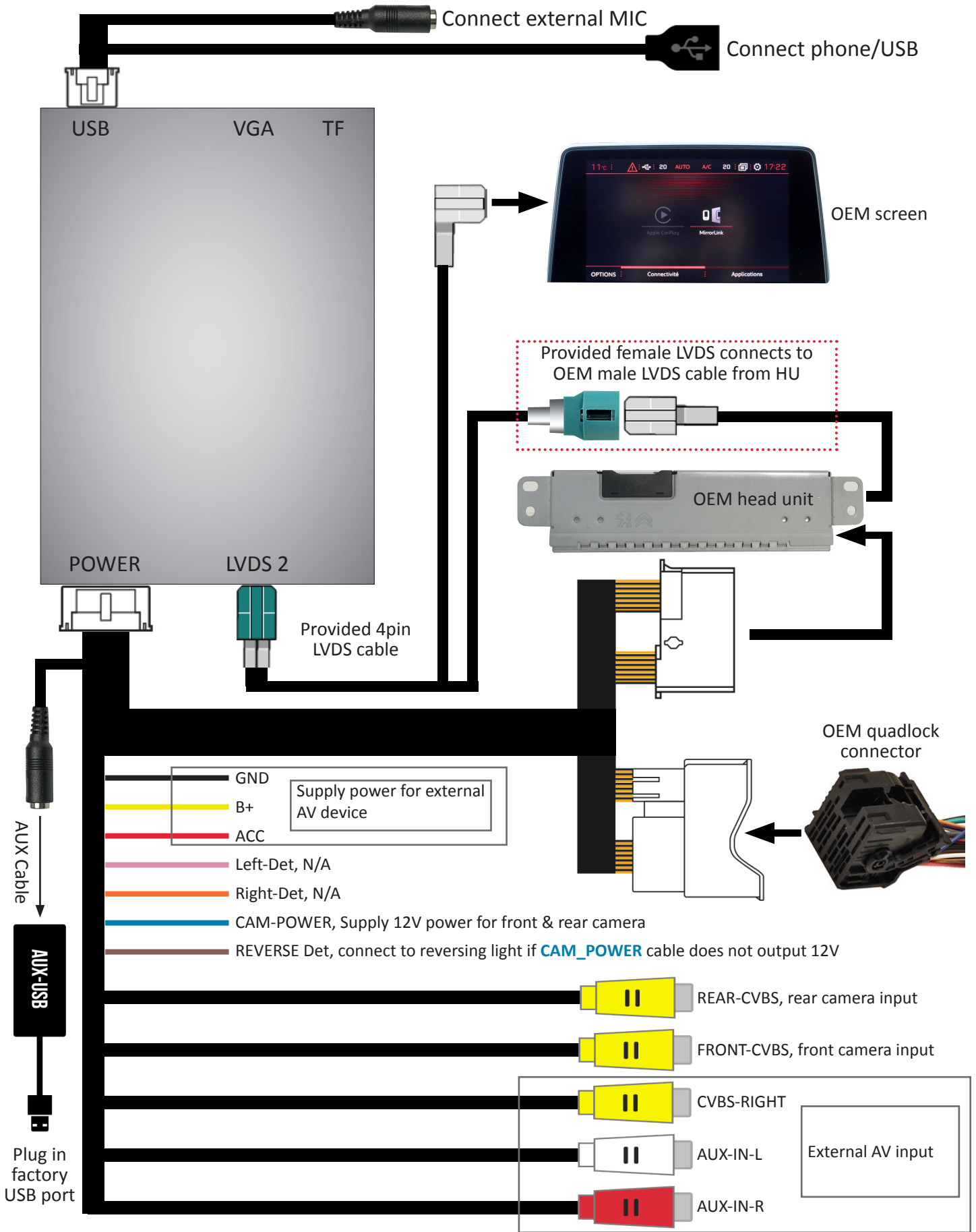

# CONNECTION DIAGRAM



# DIP SETTING

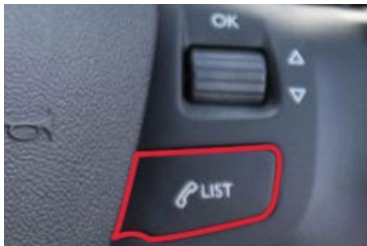

PIN	ON ↓	OFF ↑
1	<p>"LIST" and "PHONE" in <b>one</b> button on steering wheel</p> 	<p>"LIST" and "PHONE" in <b>two</b> buttons on steering wheel</p> 
2	Disable 360 panoramic	Enable 360 panoramic
3	CVBS	VGA
4	Display front view camera for 10S automatically after shifted from "R" gear	Disable front view camera
5	7 inch factory screen	8 inch factory screen
6	Reserved	
7	Original rear view camera	Aftermarket rear view camera
8	External microphone	Original microphone

**NOTE!** Please reboot the interface for effective after changing any DIP setting.



# OPERATION INSTRUCTION

- HOW TO SWITCH FROM ORIGINAL TO ADD ON INTERFACE

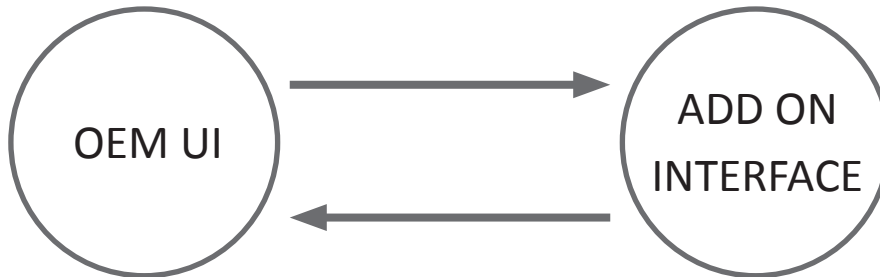

Long press "LIST" on steering wheel or "MENU" button. It will also switch to the add on interface when plug in a phone/USB stick to USB port.



- HOW TO DELIVERING AUDIO TO OEM RADIO

Plug AUX-USB adapter into factory USB port, select audio source to "AUXUSB" on OEM radio.



● ADD ON MODULE UI

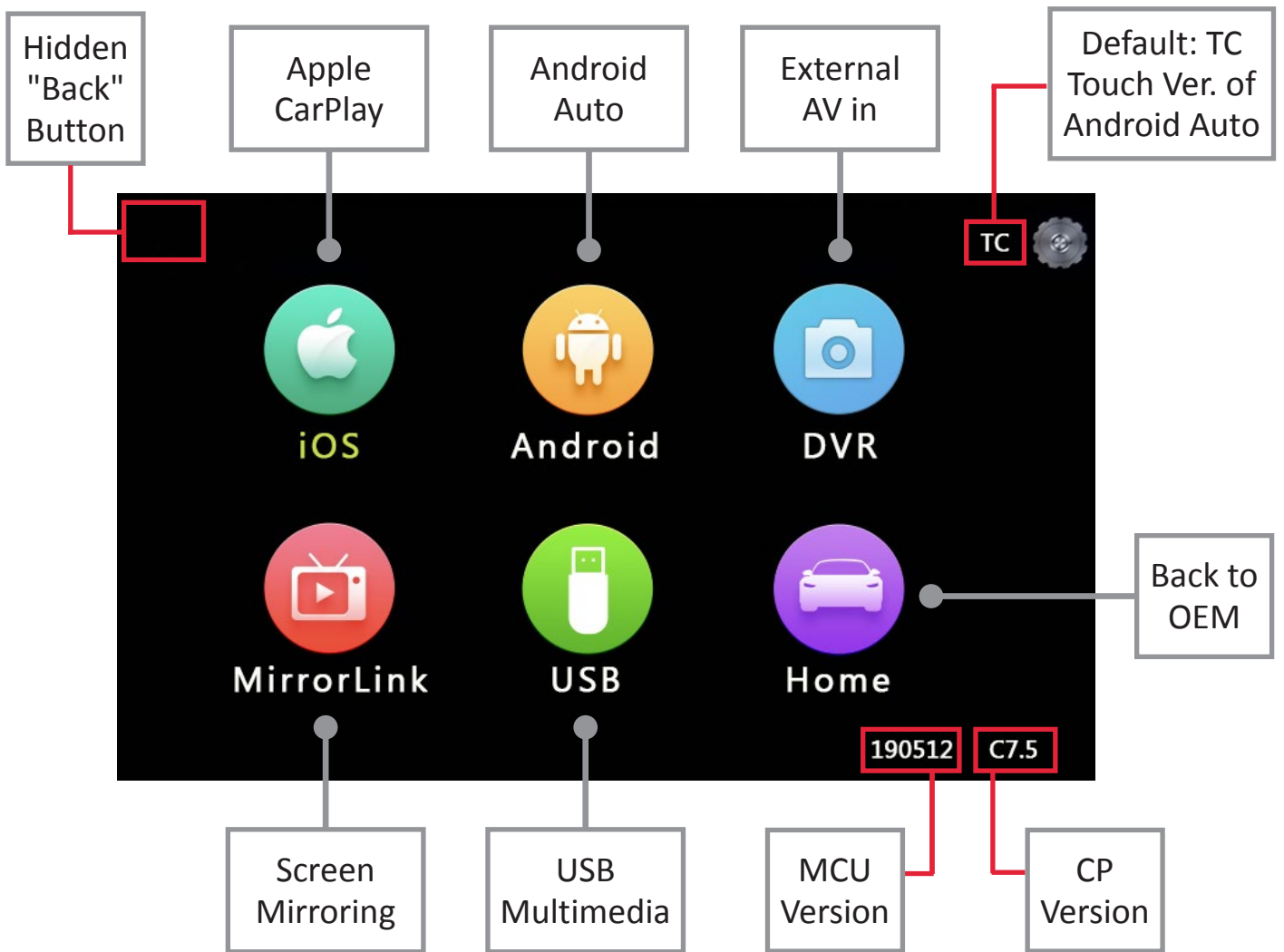

## ● APPLE CARPLAY

**NOTE!** Please disconnect iPhone's bluetooth before using Apple CarPlay.

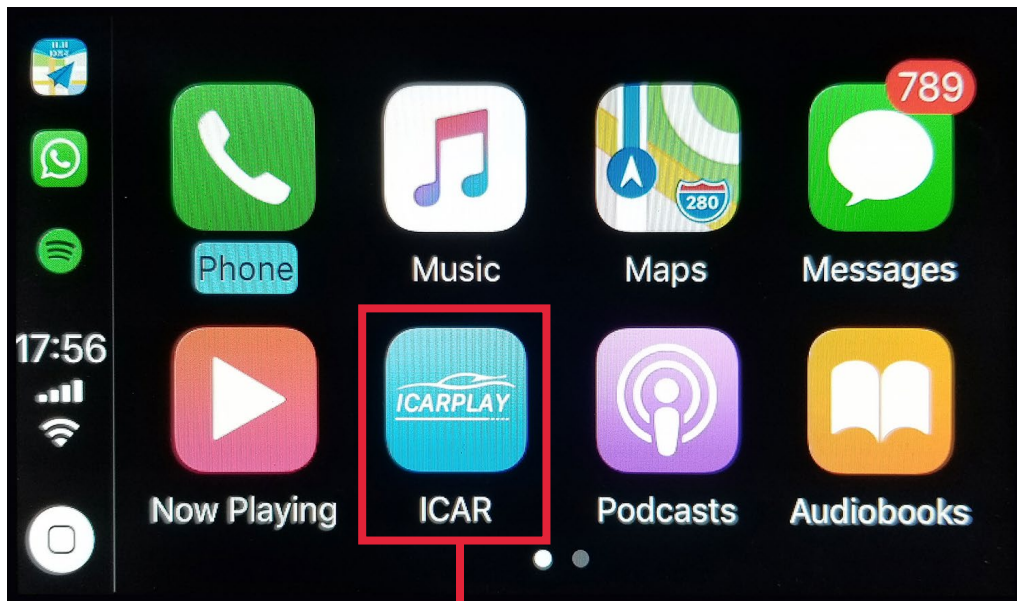

Back to add on main menu

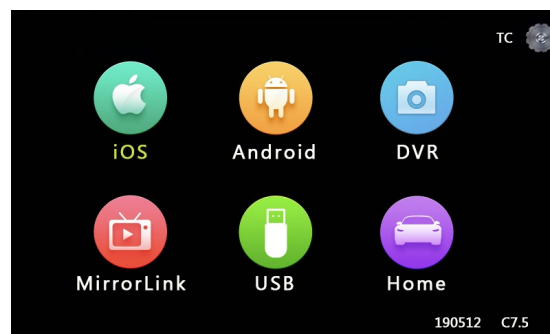

**Steering wheel control:**



## ● ANDROID AUTO

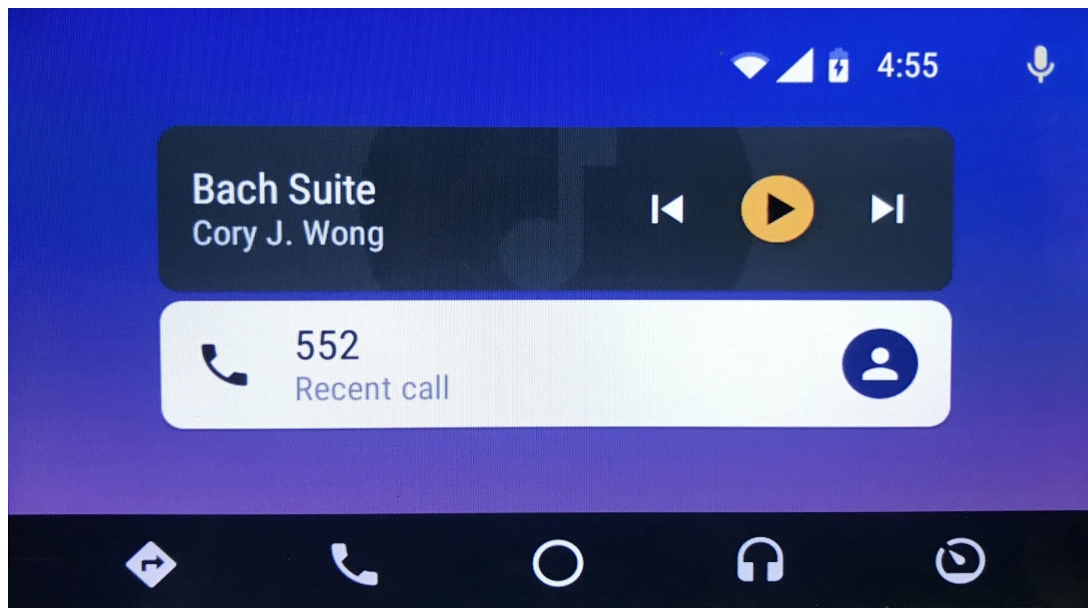

Steering wheel control is same as CarPlay mode.

**NOTE!** Make sure smartphone connect to original car stereo Bluetooth (**tick CALL AUDIO, uncheck MEDIA AUDIO**) for phone call audio delivering when using Android Auto.

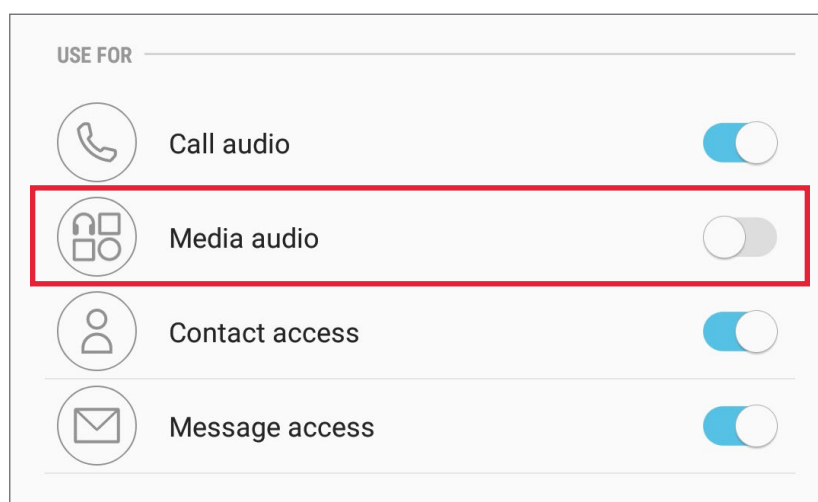

## ● SCREEN MIRRORING



Connect Android smartphone/iPhone with USB cable, and then select **“MirrorLink”** for screen mirroring.

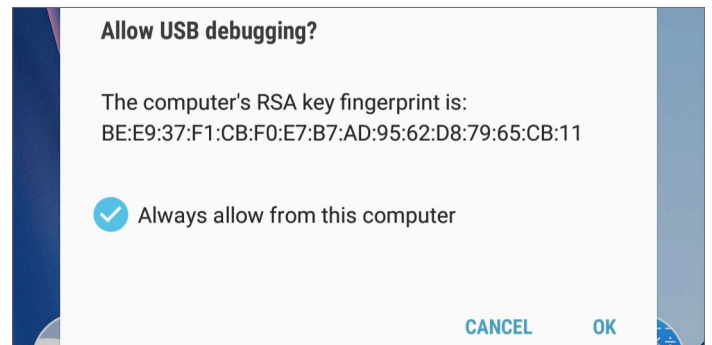
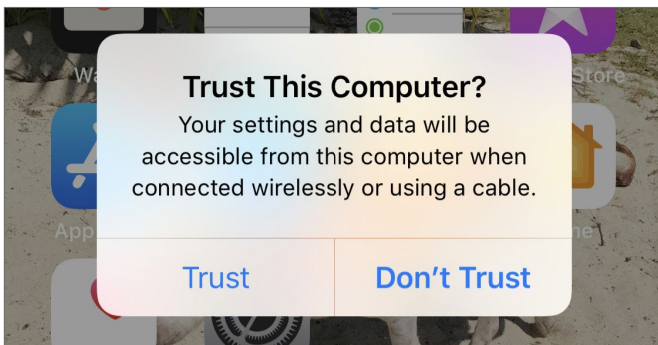

### **NOTE!**

- Please always trust or allow when pop up notification.
- Enable “USB Debugging” on an Android device
- Android device must connect to car stereo BT for all audio delivering

