

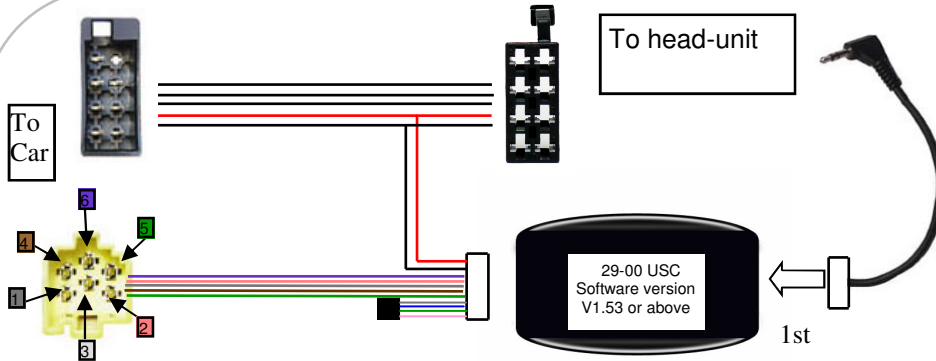

E-Mail: [sales@incartec.co.uk](mailto:sales@incartec.co.uk)  
 Website: [www.incartec.co.uk](http://www.incartec.co.uk)

### Steering Control Adapter 29-608

All Renault cars with direct wired stalk control  
 Without display. Clio (98>)Megane , Kangoo , Trafic  
 Clio Campus (07>)& Cars with 6 wires in yellow mini ISO



**1-ALWAYS CONNECT THE HEAD-UNIT CABLE ADAPTER 1st before ignition is turned on!**

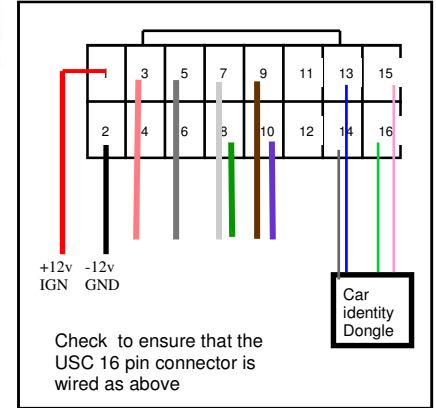

1. Choose a head-unit adapter from the list overleaf and connect it to the USC black box.
2. Turn off the ignition supply to the car!
3. Remove the OEM head-unit and identify the audio connector and ensure it mates correctly with the connector supplied with the 29 series cable.
4. **Ensure that the yellow mini ISO connector in the car has 6 individual wires!!!**
5. Connect the 29 series cable to the car and to the ISO connectors on the new radio.
6. Check that the red wire is a 12V IGNITION source in the car then turn on ignition
7. Test unit before fully fitting radio and trims back.

**If Problems:** Check that correct adapter has been used and links are in the correct place. Always disconnect from the power supply if you change the head-unit adapter lead. Check that Red wire is 12V ignition and not Permanent power. Check that head-unit is earthed and black wire is earth. Check all connections are the same as the wiring diagram shown here



E-Mail: [sales@incartec.co.uk](mailto:sales@incartec.co.uk)  
 Website: [www.incartec.co.uk](http://www.incartec.co.uk)

### Steering Control Adapter 29-608

All Renault cars with direct wired stalk control  
 Without display. Clio (98>)Megane , Kangoo , Trafic  
 Clio Campus (07>)& Cars with 6 wires in yellow mini ISO

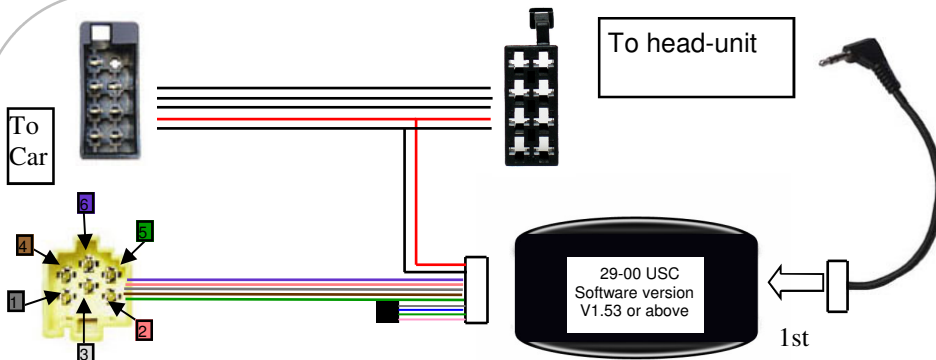

**1-ALWAYS CONNECT THE HEAD-UNIT CABLE ADAPTER 1st before ignition is turned on!**

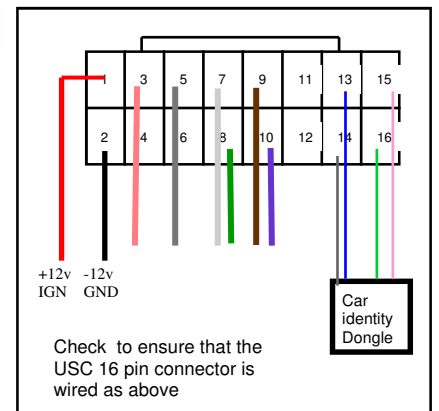

1. Choose a head-unit adapter from the list overleaf and connect it to the USC black box.
2. Turn off the ignition supply to the car!
3. Remove the OEM head-unit and identify the audio connector and ensure it mates correctly with the connector supplied with the 29 series cable.
4. **Ensure that the yellow mini ISO connector in the car has 6 individual wires!!!**
5. Connect the 29 series cable to the car and to the ISO connectors on the new radio.
6. Check that the red wire is a 12V IGNITION source in the car then turn on ignition
7. Test unit before fully fitting radio and trims back.

**If Problems:** Check that correct adapter has been used and links are in the correct place. Always disconnect from the power supply if you change the head-unit adapter lead. Check that Red wire is 12V ignition and not Permanent power. Check that head-unit is earthed and black wire is earth. Check all connections are the same as the wiring diagram shown here

CHOOSE THE CORRECT HEAD-UNIT ADAPTER FROM THOSE BELOW

29-001 Alpine



29-002 Blaupunkt

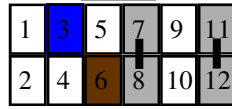

29-003 Clarion

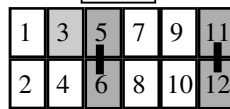

29-004 JVC

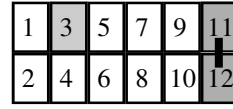

29-005 Kenwood  
Single wire

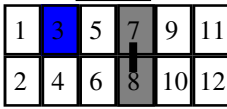

29-005D Kenwood  
4 pin DIN Plug

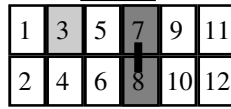

29-006 Panasonic  
Standard CD units



29-006A Panasonic  
AV head-units



29-009 Siemens  
VDO

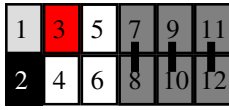

29-008 Sony  
3v & 5v units

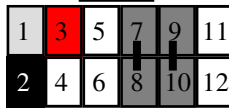

29-011 Zenec

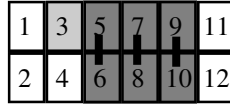

29-020 Pioneer &  
Sony

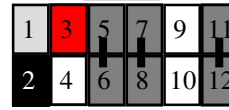

Special external drive  
PCB version

CHOOSE THE CORRECT HEAD-UNIT ADAPTER FROM THOSE BELOW

29-001 Alpine



29-002 Blaupunkt



29-003 Clarion



29-004 JVC

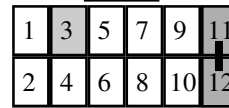

29-005 Kenwood  
Single wire

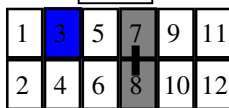

29-005D Kenwood  
4 pin DIN Plug



29-006 Panasonic  
Standard CD units



29-006A Panasonic  
AV head-units



29-009 Siemens  
VDO



29-008 Sony  
3v & 5v units



29-011 Zenec

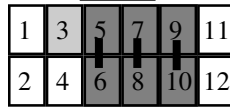

29-020 Pioneer &  
Sony

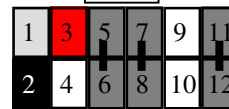

Special external drive  
PCB version