

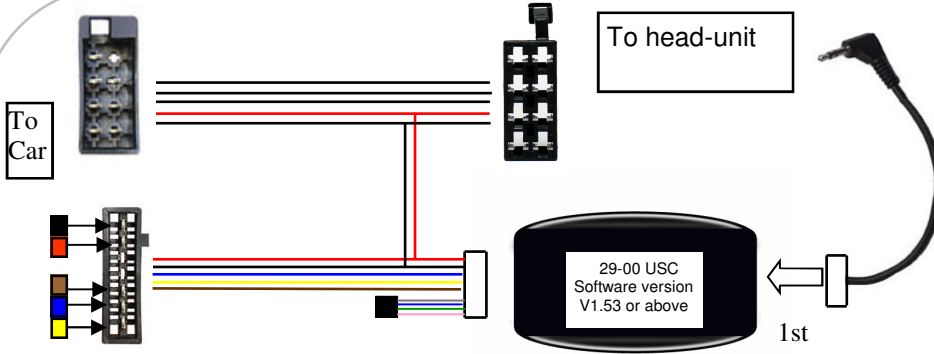

E-Mail: sales@incartec.co.uk
 Website: www.incartec.co.uk

Steering Control Adapter 29-602
 Renault cars with separate display Philips radio
 Megane, Laguna, Scenic (<05)
 Cars with Philips Display & 7 way connector



1-ALWAYS CONNECT THE HEAD-UNIT CABLE ADAPTER 1st before ignition is turned on!

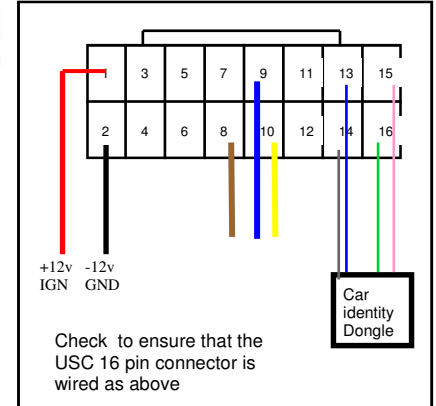

1. Choose a head-unit adapter from the list overleaf and connect it to the USC black box.
2. Turn off the ignition supply to the car!
3. Remove the OEM head-unit and identify the audio connector and ensure it mates correctly with the connector supplied with the 29 series cable.
4. Locate the 7 pin Steering control connector.
5. Connect the 29 series cable to the car and to the ISO connectors on the new radio.
6. Check that the red wire is a 12V IGNITION source in the car then turn on ignition
7. Test unit before fully fitting radio and trims back.

The cars display will show the name of the Head-unit and basic function description e.g VOL UP

If Problems: Check that correct adapter has been used and links are in the correct place. Always disconnect from the power supply if you change the head-unit adapter lead. Check that Red wire is 12V ignition and not Permanent power. Check that head-unit is earthed and black wire is earth. Check all connections are the same as the wiring diagram shown here



E-Mail: sales@incartec.co.uk
 Website: www.incartec.co.uk

Steering Control Adapter 29-602
 Renault cars with separate display Philips radio
 Megane, Laguna, Scenic (<05)
 Cars with Philips Display & 7 way connector

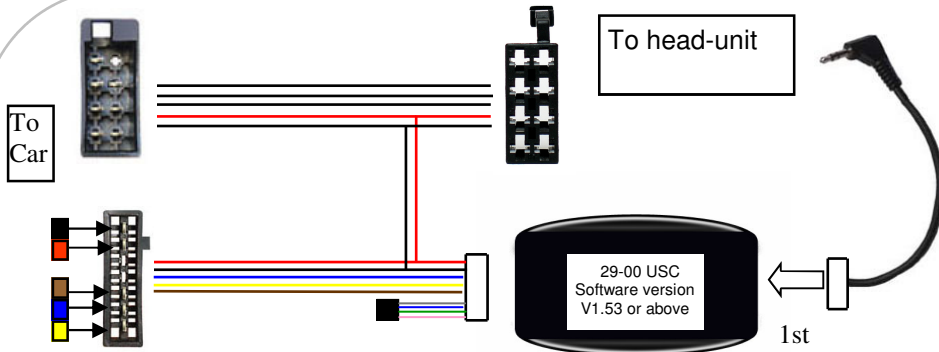

1-ALWAYS CONNECT THE HEAD-UNIT CABLE ADAPTER 1st before ignition is turned on!

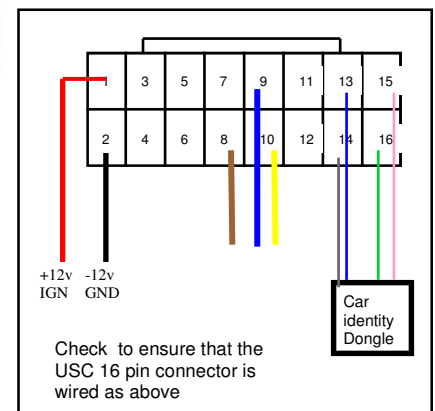

1. Choose a head-unit adapter from the list overleaf and connect it to the USC black box.
2. Turn off the ignition supply to the car!
3. Remove the OEM head-unit and identify the audio connector and ensure it mates correctly with the connector supplied with the 29 series cable.
4. Locate the 7 pin Steering control connector.
5. Connect the 29 series cable to the car and to the ISO connectors on the new radio.
6. Check that the red wire is a 12V IGNITION source in the car then turn on ignition
7. Test unit before fully fitting radio and trims back.

The cars display will show the name of the Head-unit and basic function description e.g VOL UP

If Problems: Check that correct adapter has been used and links are in the correct place. Always disconnect from the power supply if you change the head-unit adapter lead. Check that Red wire is 12V ignition and not Permanent power. Check that head-unit is earthed and black wire is earth. Check all connections are the same as the wiring diagram shown here

CHOOSE THE CORRECT HEAD-UNIT ADAPTER FROM THOSE BELOW

29-001 Alpine

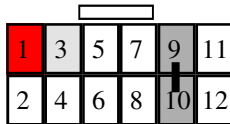

29-002 Blaupunkt

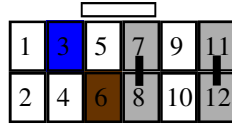

29-003 Clarion

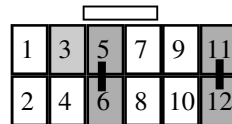

29-004 JVC

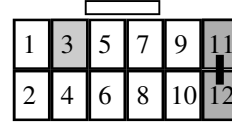

29-005 Kenwood
Single wire

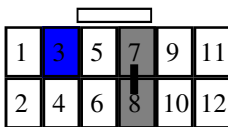

29-005D Kenwood
4 pin DIN Plug

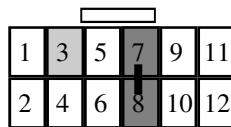

29-006 Panasonic
Standard CD units

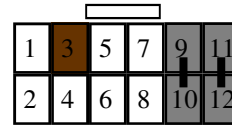

29-006A Panasonic
AV head-units

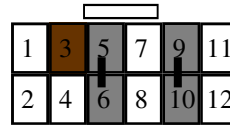

29-009 Siemens
VDO

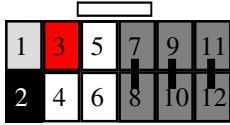

29-008 Sony
3v & 5v units

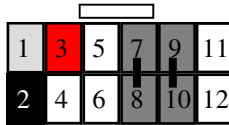

29-011 Zenec

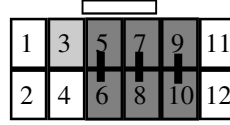

29-020 Pioneer &
Sony

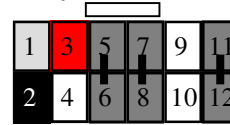

Special external drive
PCB version

CHOOSE THE CORRECT HEAD-UNIT ADAPTER FROM THOSE BELOW

29-001 Alpine

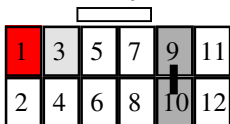

29-002 Blaupunkt

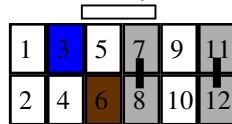

29-003 Clarion

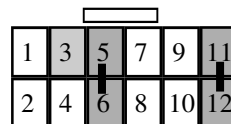

29-004 JVC

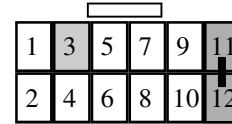

29-005 Kenwood
Single wire

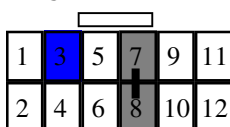

29-005D Kenwood
4 pin DIN Plug

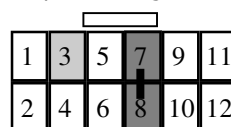

29-006 Panasonic
Standard CD units

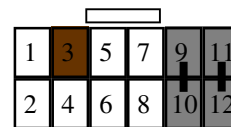

29-006A Panasonic
AV head-units

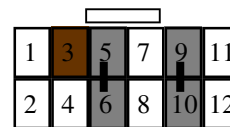

29-009 Siemens
VDO

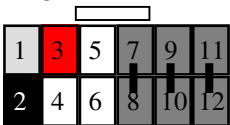

29-008 Sony
3v & 5v units

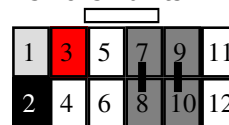

29-011 Zenec

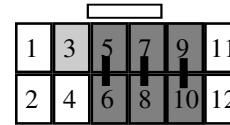

29-020 Pioneer &
Sony

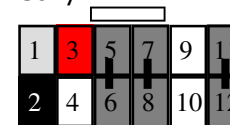

Special external drive
PCB version